

SILENCE^o
URBAN ECOMOBILITY



S02 *Low speed*
LS

USER MANUAL

(V002)

HELLO SILENCER

We present the new S02 LS electric scooter, a 50 cm³ model designed for urban use and 100% *Made in Barcelona*.

S02 LS, the electric scooter with the best battery. Created, designed and patented by SILENCE, this is a trolley-type removable battery with wheels, which breaks the barriers of charging points, allowing the user to comfortably and safely carry the battery and charge it in any conventional power point: at home, in the office, in a bar ... It can be charged anywhere, without the need for a specific charging point or infrastructure.

This model has a maximum speed of 45 km/h and its battery has a range of 52 km (2 kWh battery) or 149 km (5.6 kWh battery), offering a high range in cities, saving approximately 85% on fuel when compared with combustion engine motorcycles.

The new zero-emission scooter is packed with technology features and has an attractive design, to ensure a safe, modern and silent urban driving experience. The best way to accelerate in the change towards sustainable urban mobility.

Do you accept SILENCE's challenge to improve our cities?

Before you drive S02 LS for the first time, read this user manual, ensuring your safety and preventing damage to the vehicle or third parties. Always take your scooter to a SILENCE Official Service Centre for maintenance.

Enjoy smooth riding, with no noises or vibrations.

Thank you for choosing SILENCE S02 LS!

ABOUT THIS MANUAL

Please read the whole manual carefully and pay special attention to the safety instructions. It explains everything you need to know as an S02 LS driver. It should be considered part of the scooter, so if you sell the scooter, the manual must go with it.

The information in this manual is the most recent available for this model as of the date of approval for publication/printing. Scutum Logistic S.L. reserves the right to make changes at any time and without prior notice, without incurring any obligation. No part of this manual may be reproduced without written authorisation.

The images in this manual may show optional accessories installed (not included in standard models), as well as elements with colours that may differ in real life.

If you experience an incident with your S02 LS, please refer to the “**TROUBLESHOOTING**” section first. In addition, if you have any doubts, click on the link below to read the **FAQs**: <https://www.silence.eco/soporte/>

If you need additional support, please contact a SILENCE Official Service Centre.

SAFETY

Driving a vehicle requires your full attention and can affect your own safety and that of others. You are therefore responsible for taking any precautions necessary to minimise the risks when using your SILENCE S02 LS.

This section in particular, and the manual in general, provides information and recommendations to make driving your scooter as safe as possible. However, it cannot take into account or warn you of all of the dangers associated with driving a vehicle and its maintenance, which is why you must use common sense in order to enjoy your scooter with minimum risk. The most important recommendations are set out below.

1) Use and maintenance

SILENCE S02 LS is an urban scooter designed to be used only on roads, carrying at most the driver and one passenger. It is also important to respect the maximum load indicated in the "**Carrying loads**" section.

Respect your limits while driving: Take your personal abilities and the road conditions into account in order to drive safely. Do not overestimate them and leave room for the unexpected.

Do not drink or take drugs before driving: Your reactions will be impaired and so will your ability to avoid unexpected hazards. Do not let anyone else drive in that condition either.

Assess other factors: Also take other factors into account that affect driving, such as prescription drugs, tiredness or lack of attention.

Properly maintain the scooter: Just as you have to be in good shape to drive, it is your responsibility to check and maintain your scooter before driving, following the instructions in this manual (refer to the "**MAINTENANCE SCHEDULE**" section). Inadequate or no maintenance can be a risk factor.

2) Clothing and protection



For your safety and that of the passenger, we recommend wearing the right protective clothing when driving the scooter. Although it does not provide total protection, it can considerably reduce the probabilities of injury and the seriousness of the consequences. Consult a specialist to choose the clothing that best suits you.

Always wear a helmet: Proper use of a helmet is basic and obligatory, both for the driver and for the passenger. It must be approved, in good condition and **fastened properly**. Helmets reduce the number of head injuries and their seriousness. We recommend using **full face** helmets (that cover the whole head) over open face helmets (jet or three-quarter helmets), in **light, bright colours or with reflector strips**, that are lightweight and **fit properly**.

Protect your eyes: Always use eye protection, either the visor of the helmet or the appropriate glasses.

Other garments: Wear stiff boots and leather gloves to protect your feet, ankles and hands from scratches, cuts and bruises. Wear a suit or jacket and trousers specifically designed for use on a scooter. These should be form-fitting and the right size, and we recommend they have reflector strips.

These recommendations also apply to the passenger, if there is one.

3) Carrying loads

This scooter is designed to be driven safely as long as the maximum load capacity and its distribution are respected. Failure to do so may compromise the stability, braking and manoeuvrability of the scooter.

The maximum weight of the scooter must not exceed 282 kg, including the vehicle itself with its battery and accessories, the driver and the passenger (when applicable), and the load. The weight carried must be distributed evenly between the two axles, and must not exceed 111 kg on the front axle or 172 kg on the rear axle.

Remember that the weight of any accessories installed will reduce the weight of the maximum load that the scooter can carry.

Recommendations

- Distribute the load evenly on the scooter, and try to keep it as close to the centre as possible.
- Make sure the load is firmly strapped down, and avoid carrying loose objects.
- Always make sure tyres are properly inflated, and adjust the rear suspension to suit the specific load in each case.

4) Accessories and modifications

We recommend using only original SILENCE accessories, as they have been designed and tested to ensure they work properly with this model of scooter. If you use other accessories or modify them in any way, you must make sure they are installed and chosen properly, so that they:

- Don't reduce the turning radius of the handlebar or interfere with the use of any of the controls.
- Don't reduce the side angle of inclination or distance to the ground.
- Don't interfere with visibility or the beam of any of the lights.
- Don't tamper with the electrical or electronic components of the scooter.
- Comply with legal regulations.

CONTENTS OF THIS MANUAL

HELLO SILENCER	2
ABOUT THIS MANUAL.....	3
SAFETY	4
1) Use and maintenance	4
2) Clothing and protection	5
3) Carrying loads	6
4) Accessories and modifications	6
CONTENTS OF THIS MANUAL	7
VEHICLE IDENTIFICATION.....	9
1) VIN number – chassis number	9
2) Production information label.....	9
BASIC COMPONENTS AND FUNCTIONING	10
1) Battery pack (“be”)	11
2) Motor (rear wheel)	11
3) Dashboard	12
4) Vehicle controls and driving.....	20
5) Ignition	27
6) Lighting	28
7) Seat - Compartment under the seat	30
8) Stands	35
9) Rear-view mirrors	35
10) Accessories	35
TECHNICAL SPECIFICATIONS	36
1) Scooter specifications (chassis + motor).....	36
2) Battery and charger specifications	38
BATTERY PACK.....	40
1) Components	40
2) Energy.....	42
3) Exchanging batteries (<i>available soon</i>).....	43

4) Battery management system (BMS).....	44
5) Connecting the charging unit	44
6) Temperature.....	46
7) Battery charge level, in % (SoC).....	46
8) Range.....	47
9) Best practices to ensure proper battery maintenance	47
10) Safety information regarding the battery	48
DISPOSAL AND RECYCLING	50
1) Recycling the battery pack.....	50
2) Recycling the scooter	50
MAINTENANCE SCHEDULE	51
1) Operations and frequency	52
2) Cleaning	52
3) Storage	53
4) Checks before driving.....	53
TROUBLESHOOTING	57
VEHICLE AND BATTERY WARRANTY	58
1) Delivery to buyer	58
2) Warranty terms and conditions (grounds for voiding the warranty)	59
3) Inspection: Scooter and battery.....	60

VEHICLE IDENTIFICATION

1) VIN number - chassis number

The VIN is a 17-digit alphanumeric code that identifies your scooter and which is engraved directly on the chassis, on the central beam of the tubular bar section, between the driver's legs. This engraved code can be checked by removing the plastic cover (image).

The VIN standard is determined in the ISO standard. **The VIN number must be given when ordering replacement parts.**

2) Production information label

This scooter has a label with the chassis and approval number, among other information.

The label is found on the front part of the battery compartment:



UCYS0?????000001

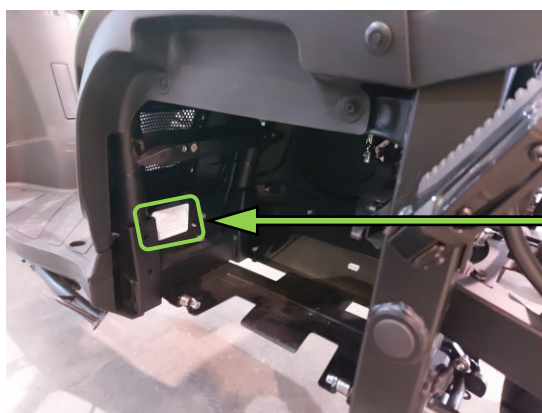

SCUTUM LOGISTIC, S.L.			
L1e - B			
○	e9*168/2013*11589	○	
○	UCYS02B00MB000001	○	
○	dB(A) -	min ⁻¹	○
1,6	kW	45	km/h max 282 Kg
TYPE: S02B			

BASIC COMPONENTS AND FUNCTIONING

The basic components (user level) that make up this scooter are:

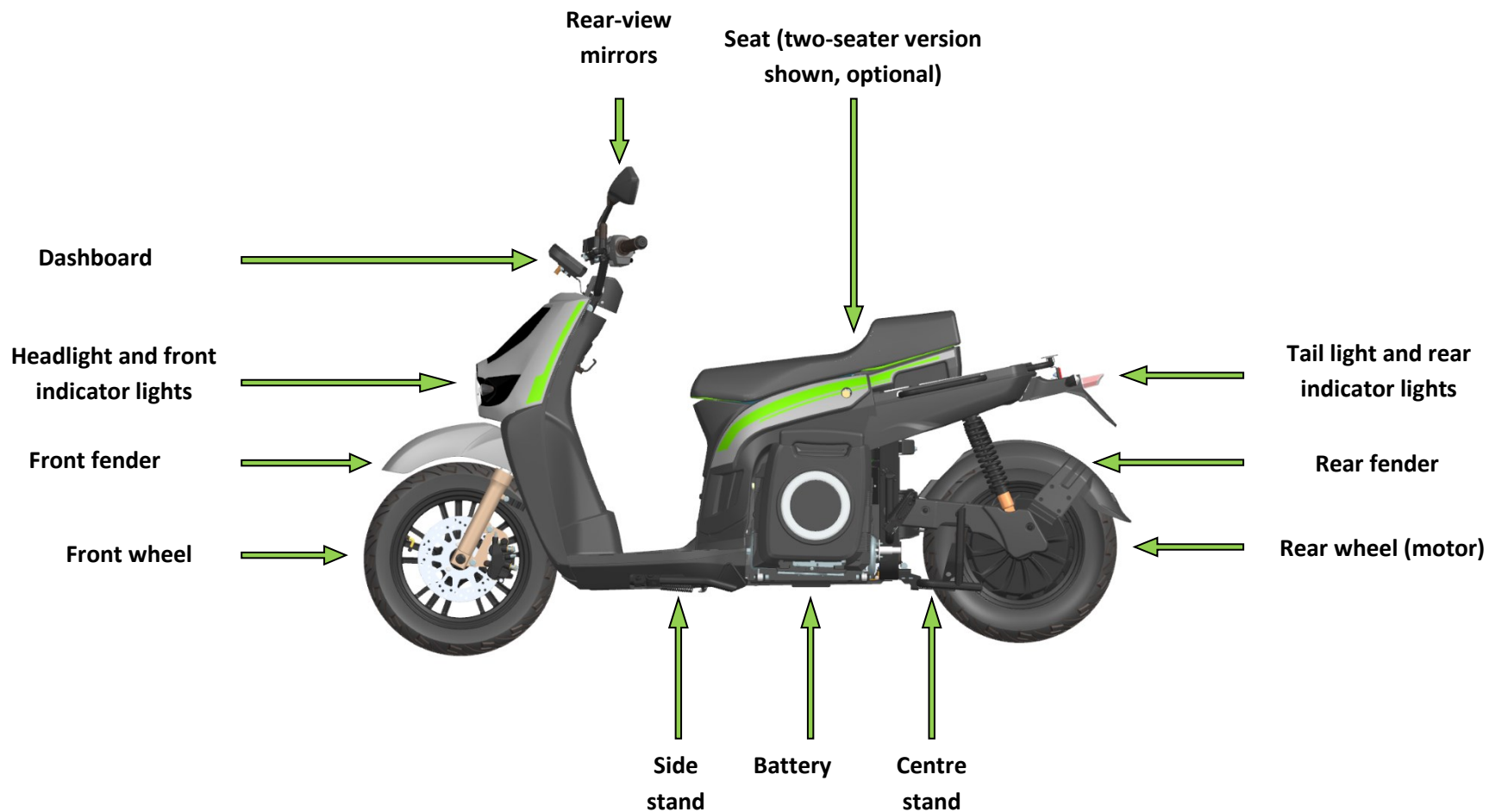

1) Battery pack (“be”)

The SILENCE S02 LS model has an innovative removable battery pack with a handle and wheels so it can be transported like a *trolley*, called “*be*”. This means you can charge it on the scooter or wherever you want, simply by taking the battery to a power source. This battery pack can also be used on other scooters, or even used to power other devices.

For more information, refer to the “**BATTERY PACK**” section, which describes all the features and functions of your new battery.

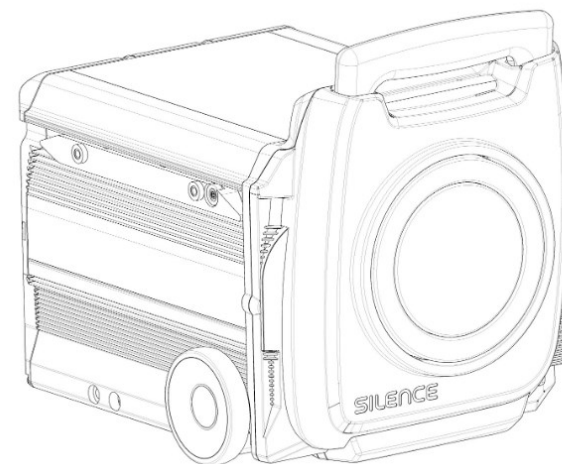

2) Motor (rear wheel)

On the rear wheel, this scooter has a 100% electric motor with *Brushless* technology, direct transmission and an air cooling system.

Its nominal power is 1.6 W (L1e approval) and it has a maximum speed of 45 km/h.



3) Dashboard

The dashboard provides you with all of the information you need about the scooter in order to drive it.

It features an LCD screen, 2 buttons (“SET” and “INFO”) and 10 hazard lights, which are explained below.

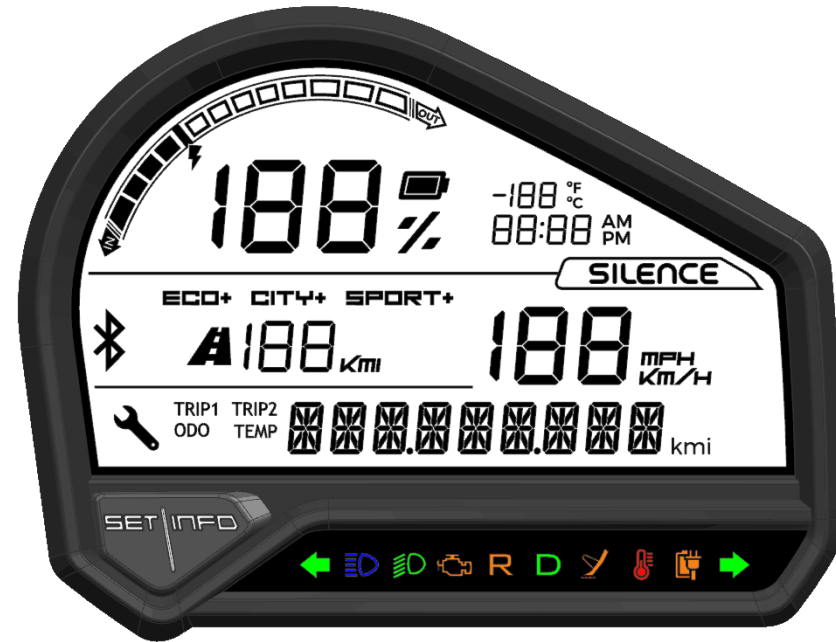

a) LCD display

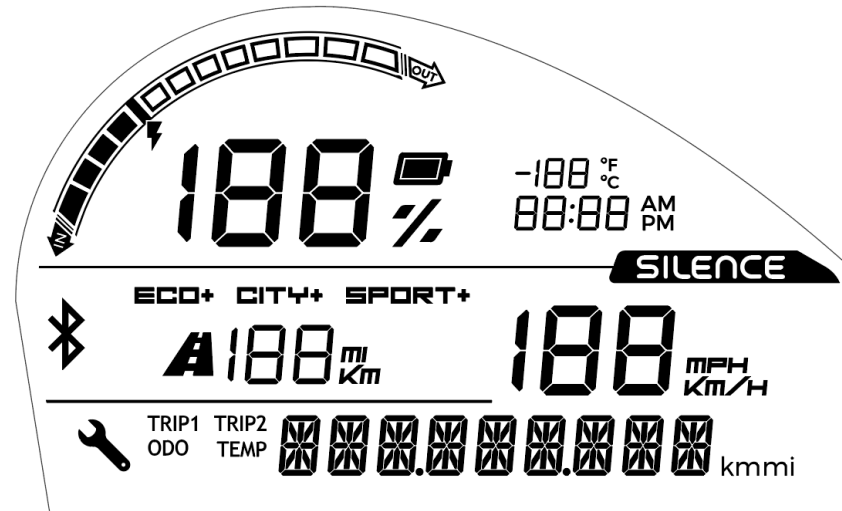

Charge level indicator

The top of the *display* shows the battery's *state of charge* (SoC). This is shown as a percentage, so when the battery is completely discharged it will read 0% and when it is fully charged it will show 100%.

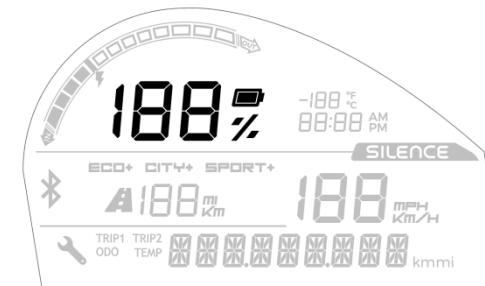

Power light

On the upper left, there is also a light that shows whether power is flowing out of the battery (“OUT”, being used) or into it (“IN”, regenerated through the motor brake or charging).

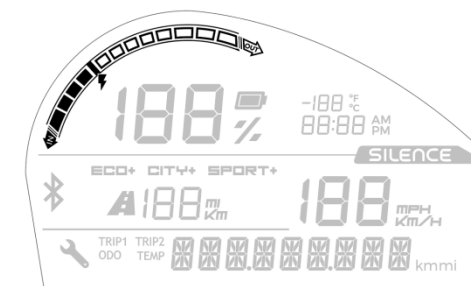

Ambient temperature

On the top right, the ambient temperature is displayed (in Celsius or Fahrenheit, depending on the settings). It shows both positive and negative temperatures.

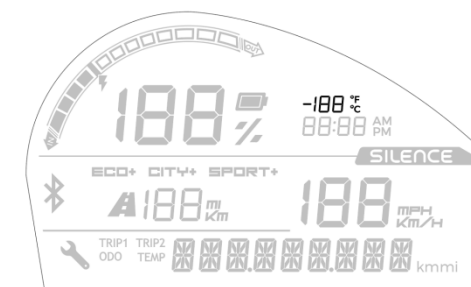

Current time

Just below that, the current time is displayed (battery data). The time can be shown using the 12-hour or 24-hour clock system.

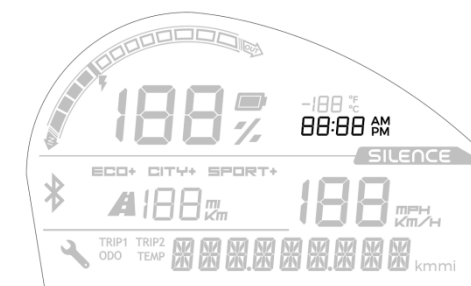

Driving mode

In the top middle area (below the charge percentage), the screen shows the current driving mode (ECO or CITY).

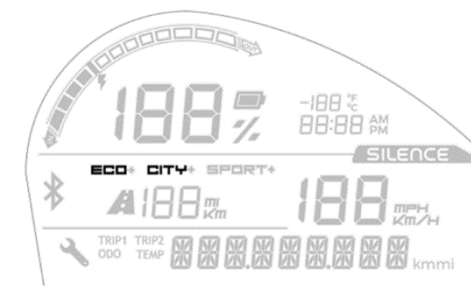

Estimated remaining range

Below the driving modes, there is information about the remaining range, in kilometres or miles. This is approximate and depends on the driving mode and current use of power.

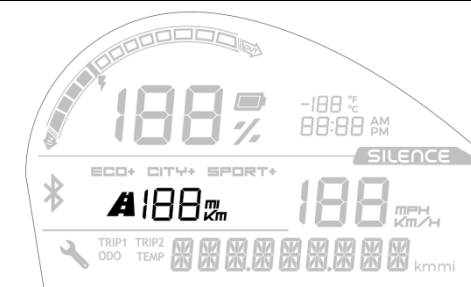

Speedometer

In the middle on the right (under the SILENCE logo), the scooter's current speed is shown. It can be set to kilometres per hour or miles per hour.

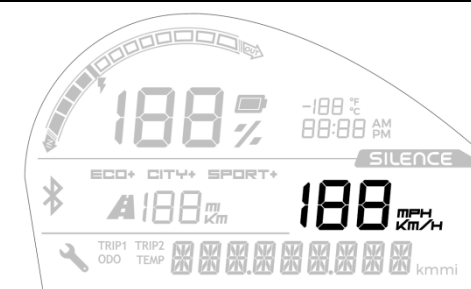

“ODO”

Odometer: indicates the total kilometres/miles travelled.

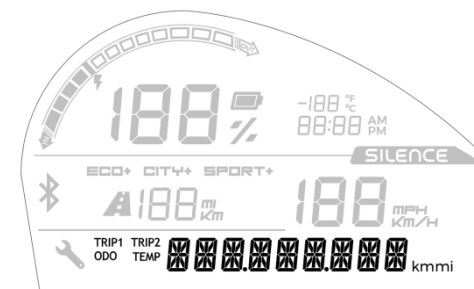

Press **INFO** once to display:

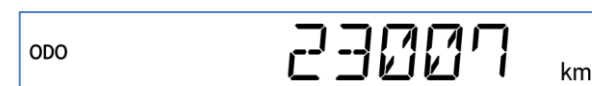

“TEMP”

Temperatures of different components, in Celsius or Fahrenheit.

Holding down the **INFO** button you can switch between:

- TEMP BAT (of the “battery pack”): battery pack temperature.
- TEMP ENG (of the “motor”): motor temperature.
- TEMP INV (of the “inverter”): inverter temperature.

Press **INFO** once to display:

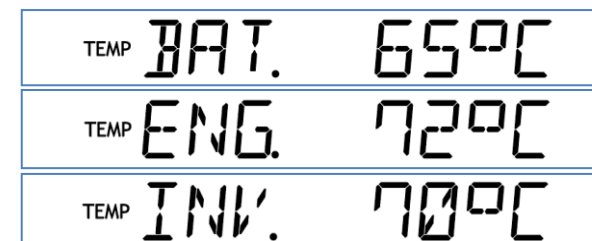

“TRIP1”

Partial odometer 1: indicates the kilometres/miles travelled since the last time it was reset.

Holding down the **INFO** button you can switch between:

- KM/MI: kilometres/miles travelled.
- AVG: average speed for these kilometres/miles (in km/h or mph).

Press **INFO** once to display:

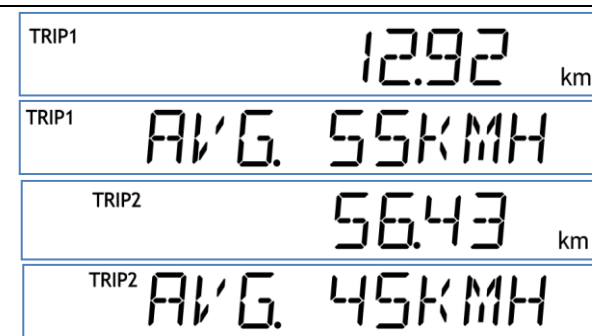

“TRIP2”

Exactly the same as TRIP1. Press **INFO** once to show ODO again.

Other messages

The bottom of the display shows other messages, such as warnings (scooter charging, side stand out, etc.), or operating errors (which start with “0x...”). If the latter appear, please contact your SILENCE Official Service Centre.



b) Buttons

The buttons on the dashboard are **SET** (left) and **INFO** (right, and the same on the controls on the right side of the handlebar):



Their functions are as follows:

Browsing panels

Press **INFO** (press once): this will take you through the following screens with each press, in this order: **ODO** -> **TEMP** -> **TRIP1** -> **TRIP2** -> **ODO** -> ...

Change view: partial km/partial miles – average speed (AVG)

In TRIP1 or TRIP2, press **INFO (hold down)**.

Reset partial Km/Miles

In TRIP1 or TRIP2, press **SET (press once)**. The kilometres will be set to zero.

Change to Temperatures view

In TEMP, press **INFO (hold down)**: navigate the screens **TEMP BAT -> TEMP ENG -> TEMP INV -> TEMP BAT -> ...**

Change Time

Press SET (and hold): you will enter the time change mode.

Press SET (press once): you will switch between hours, minutes and time mode (they will start flashing).

With the time flashing, **press INFO (press once)**: it will increase by one unit per press. **Press INFO (and hold)**: the hour will increase quickly.

With the minutes flashing, **press INFO (press once)**: it will increase by one unit per press. **Press INFO (and hold)**: the minutes will increase quickly.

With the time mode flashing, **press INFO (press once)**: this will allow you to switch between AM, PM and 24-hour mode.











Press SET (hold down): set the time and exit time change mode.

Change Unit System

Press SET (press when starting the scooter): this will switch you from the metric system (°C, km/h, km) to imperial measurements (°F, mph, mi), and vice versa.

c) Hazard lights



	Left indicator light indicator.
	High beam light.
	Low beam light.
	OBD light. It comes on when there is an issue. If it disappears, the light should go off after you start the scooter 3 times.
	Reverse gear light.
	Gear light. It comes on when the scooter has done all the necessary checks and it is ready to drive.
	Side stand (or kickstand) light. It comes on when the stand is out. Driving is not permitted with the stand out (automatic safety shutdown).
	Temperature indicator. It flashes when a component is approaching its permissible (upper or lower) limit. It stays on when it exceeds it. Motor: 100°C (int.), 110°C (fix.). Inverter: 70°C (int.), 80°C (fix.). Battery: 50°C (int.), 60°C (fix.) / 5°C (int.), -10°C (fix.)
	Charge light. Steady when connected to the mains.
	Right indicator light indicator.

4) Vehicle controls and driving

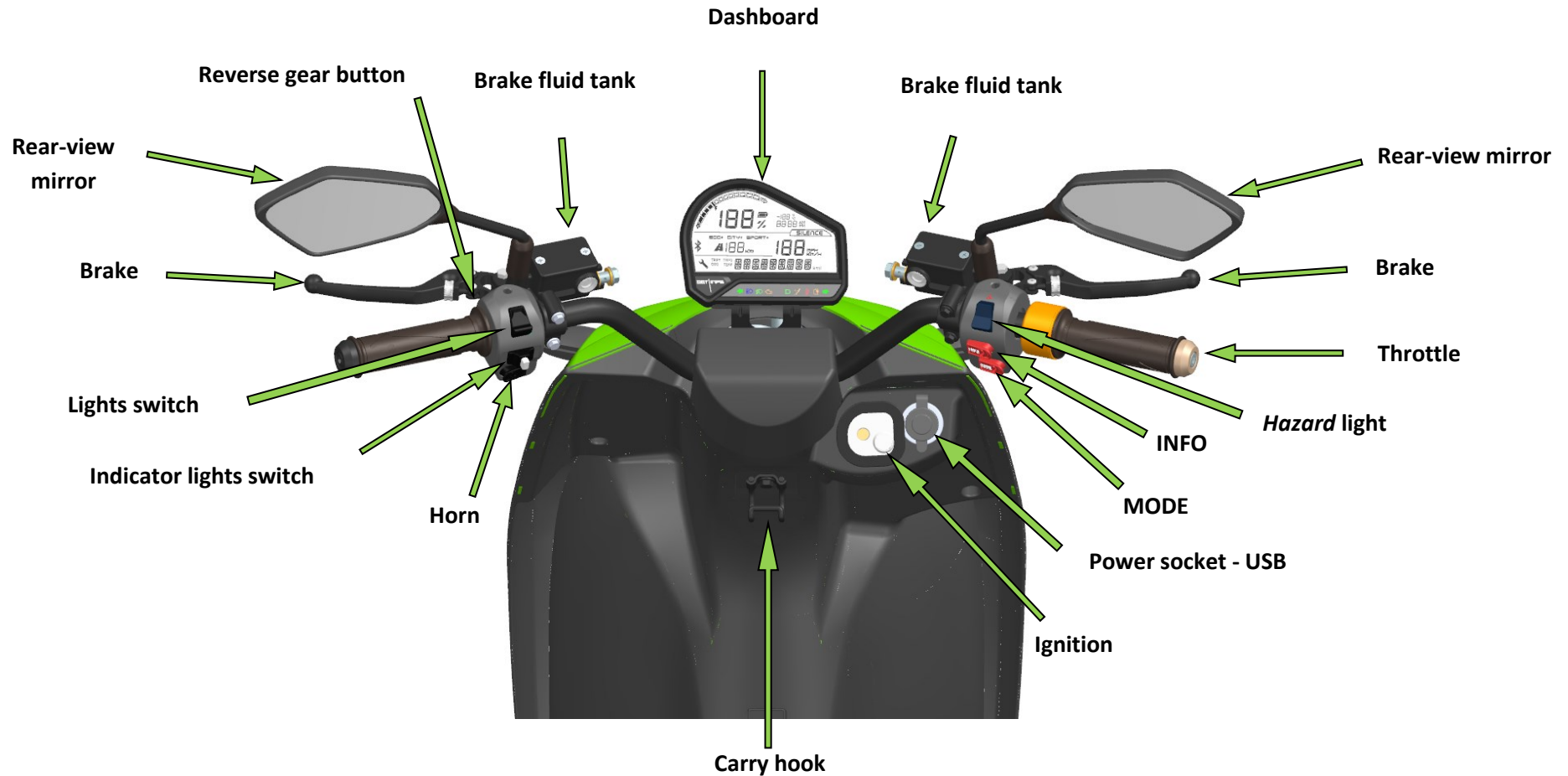

a) Combined brake and regenerative brake

This scooter is equipped with a combined braking system that works as follows:

The **right brake** mechanically brakes the front wheel (with the disc brake), while the **left brake** mechanically brakes the front and rear wheels (by applying force to both discs, thanks to a braking distribution system). Both sides electronically activate the regenerative brake of the rear wheel. Both levers are adjustable (see the “**Adjusting the brake lever**” section).

With regards to the **regenerative brake**, it can be activated by lightly pressing each lever, using it without needed to apply the mechanical brake. Then both brakes are activated together. Using the regenerative brake helps braking while maintaining battery charge.

The regenerative brake applied depends on the driving mode selected (see “**MODE**”):

- The regenerative brake is activated when either of the two levers is pressed.
This system brakes the rear wheel electronically and regenerates energy in the battery:

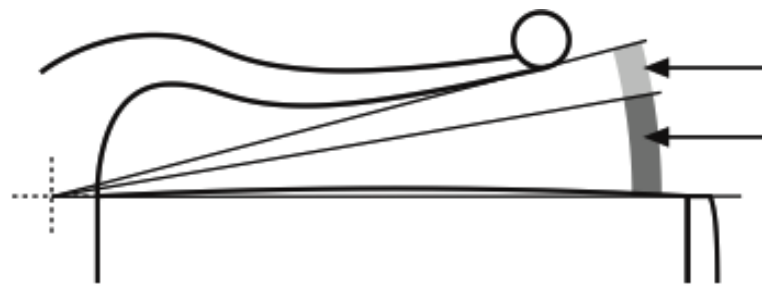

- if you continue to press the brake lever, the mechanical brake on the front wheel will also be engaged (or both, if you press the left lever); the greater the pressure applied, the greater the mechanical braking power.
- The regenerative brake is also applied when you stop accelerating (depending on the mode selected).

b) Controls on the left side of the handlebar

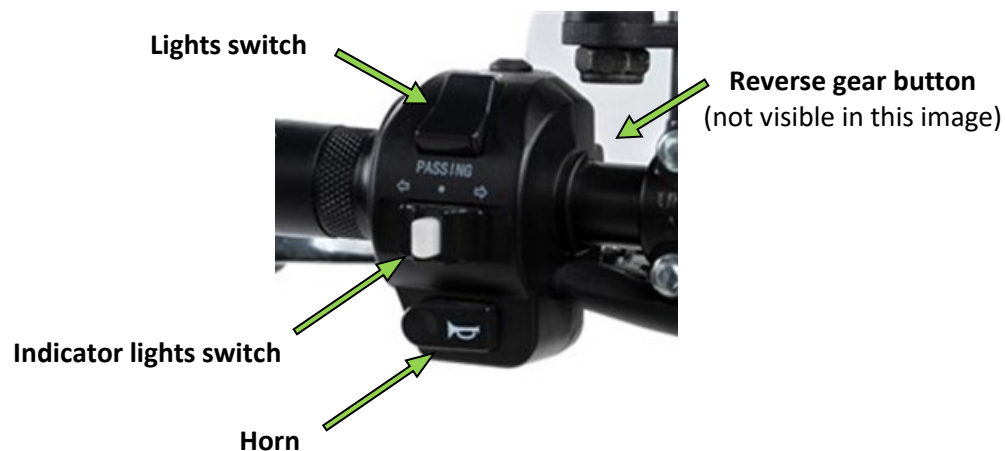

Lights switch:

- **Central position** (standby, between 1 and 2): by default, the **LOW BEAM** (when the "D" driving LED is on) and **SIDE LIGHTS**.
- **Position 1** (push-button -> press down to return to the central position): **FLASHING**. It allows you to flash high beam when it is pressed, as a warning to other drivers on the road.
- **Position 2** (switch -> remains in position 2, top): **HIGH BEAM** is added to the lights in the central position.

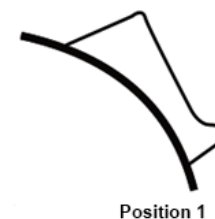

When high beam is on, the blue light below will come on in the dashboard:



Indicator lights switch:

To activate the indicator signal, move the switch to the right to indicate a turn to the right and move the switch to the left to indicate a turn to the left. The scooter will beep with each flash of the indicator light. Press the central **white** button to reset the switch position and turn the indicator lights off.

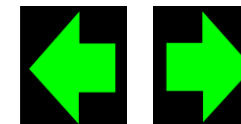
**Horn:**

Press the button **with the horn symbol** to honk the horn:

**Reverse gear switch:**

This scooter has a reverse gear. To use this function, press the **green** button behind the lift brake lever and, **while pressing it**, accelerate smoothly. The following hazard light will come on in the dashboard and make an intermittent beeping sound:



Use it carefully, especially the first time. This helps manoeuvre for parking or to get out of a parking spot in reverse gear.

c) Controls on the right side of the handlebar



Throttle:

To accelerate, twist the throttle. Move the throttle back to return to the neutral position.

Hazard lights switch:

- **Position 1:** standby position (lower).
- **Position 2** (push-button -> returns to the neutral position): **WARNINGS.** Switches the indicator lights on and off on both sides at the same time. A beeping sound will be made with each flash of the indicator light. You can switch on your *hazard* lights and leave them on with the key out of the ignition. To do so, switch them on with the key in and then remove it. After they have been switched off, they can't be switched on again without putting the key back in.

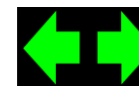

“INFO” button:

This button is the same as the INFO button on the speedometer and has the same functions (see the **“Dashboard”** section).

“MODE” button:

This button has two functions:

- **Starting the scooter:** after you start the vehicle with the key, press the **MODE** button until the green “D” lights up on the dashboard and you hear a chime. The sidelights will also switch on (the rear sidelights go on automatically when you turn the key to ON).
- **Mode selector:** this scooter has two different driving maps, which can be selected with the **MODE** button.

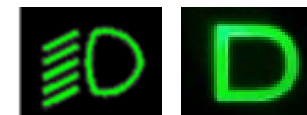

These are:

- **CITY:** default mode in which the scooter starts, which offers the best performance features. It does not use the regenerative brake.
- **ECO:** this mode is for more relaxed driving, with limited speed and acceleration. It gives the vehicle a longer range. It features a regenerative brake.

The maximum speeds, according to the chosen mode, are:

MODE	MAXIMUM SPEED
ECO	27 km/h
CITY	45 km/h

The current driving mode is shown on the dashboard.

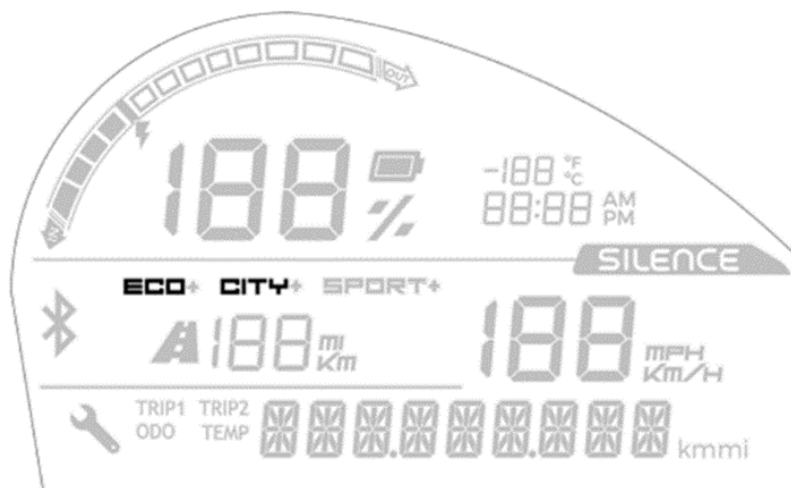

Press once to change from ECO mode to CITY mode. When switching between modes, the name of the next mode will flash on screen for a few seconds and will stop flashing when it is chosen.

For safety reasons, power will be limited in any of the following cases as a self-protection measure:

T_{bat} ≥ 60 °C	T_{mot} ≥ 110 °C	T_{inv} ≥ 80 °C
--------------------------------	---------------------------------	--------------------------------

To prevent this, the power will be reduced gradually when you reach these values.

5) Ignition

Switch positions:

a) “LOCK”: Handlebar lock

Turn the handlebar all the way to the left. Put the key in, push it in and turn to the left, to the "LOCK" position.

Now all the functions are blocked and the scooter movements are highly limited.

b) “OFF”: Shutdown / Unlocking the handlebar

All the functions are locked but the handlebar isn't (the scooter can be moved). You can work on the scooter safely.

c) “ON”: On

All functions are ready to be used. The scooter is ready to be driven if you hold the MODE button pressed until “READY” appears on the speedometer and the green drive light (D) comes on. In this position, the key cannot be removed.

d) “SHUT”: Guard closed

Insert the top slotted end of the key into the corresponding hole and turn left to protect the ignition from dust and humidity.

e) “OPEN”: Guard open

Perform this operation, turning to the right, to open the lock and insert the key.



6) Lighting

All of the lamps and lights on this scooter use LED technology, including indicator lights, sidelights, brake lights, high beam and low beam. Refer to the “**Vehicle controls and driving**” section. There are no light bulbs to change.

The various lighting groups are:

a) Headlight

Includes high beam (top), low beam (bottom) and side lights (perimeter semi-circles).

b) Front and rear indicator lights

The indicator lights are found on both sides of the headlight and tail light.

c) Tail light

The LED module is hosted on the top of the scooter, which groups the rear side, braking and registration plate lights.

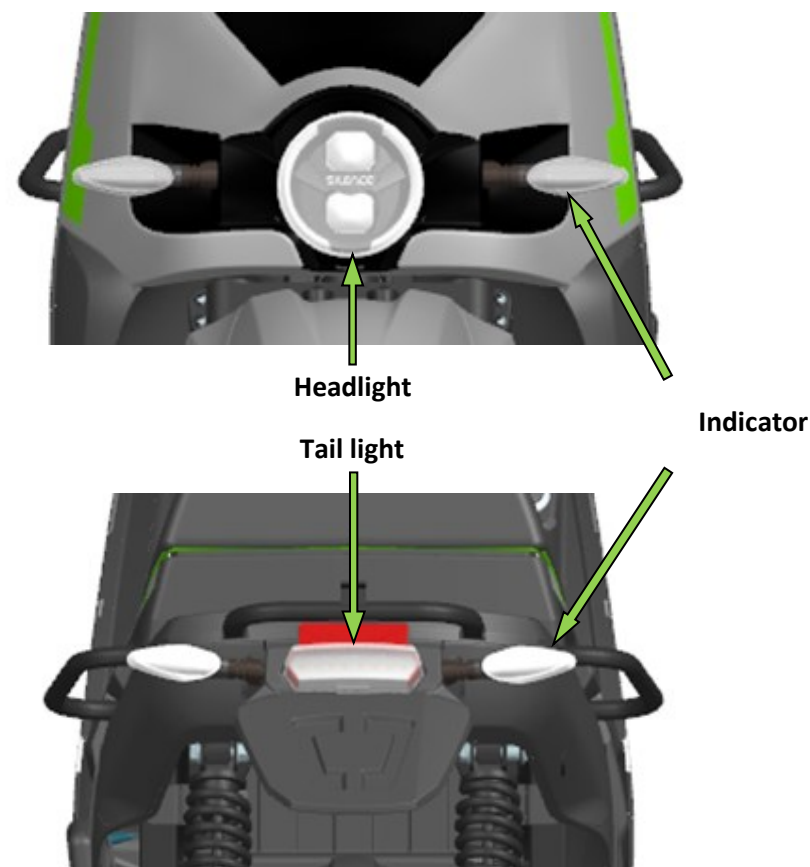

d) Headlight adjustment

To adjust the headlight, turn the screw (1) behind it, using an 8 mm ratchet wrench or a Phillips head screwdriver.



The screw is accessed from the two openings on both sides of the front fender. The adjustment screw is in a place that is not easy to access; if you cannot manage to adjust it yourself, please take the scooter to your nearest SILENCE Official Service Centre.

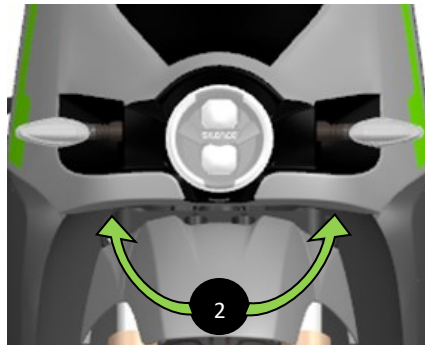

ADJUSTING THE LIGHT BEAM POSITION (UP)

To adjust the light beam position **upwards** (high and low beam), turn the screw **clockwise** (facing the scooter headlight).

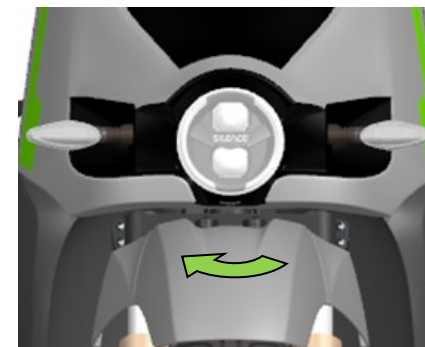

ADJUSTING THE LIGHT BEAM POSITION (DOWN)

To adjust the light beam position **downwards** (high and low beam), turn the screw **counter-clockwise** (facing the scooter headlight).

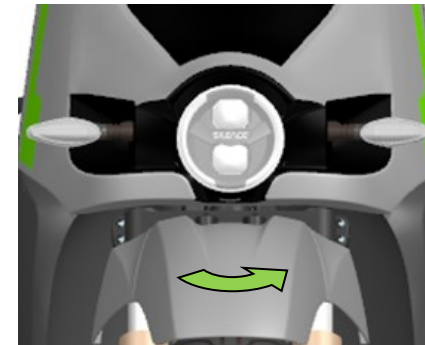

7) Seat - Compartment under the seat

a) Opening and closing the seat

Solo seats (standard) and two-seater seats (optional) are available for your S02 LS. In both cases, the seat is **opened** with the scooter's key, which must be inserted into the lock and turned clockwise. To **close it**, lower it and press on the seat until it is locked. Make sure it is locked before you start driving.



There is a small storage tray (~3L) under the seat, where you will find the following elements (explained below):



b) Removing the battery

To remove the battery pack easily in just a few seconds, follow these steps **(with the scooter on the centre stand)**:



Open the seat



Press the latch Remove the battery pack



Unfold the handle



Transport the battery pack



Connect it to any socket



Once charged, unplug it



Transport and insert the battery pack into the scooter



Make sure that the battery is properly secured

(The model shown may not correspond to the model described in the manual)

In addition, your scooter features a **latch** (since 2021, depending on the version) to prevent the battery from being removed and to increase safety.

The latch features a cylinder that locks the battery into place and is installed in front of the rear wheel, to the left, and is protected with a rubber cover:

- to activate it (and lock the battery), simply press it inwards (towards the battery).
- Use the key in the ignition to release it



IMPORTANT: Never remove or insert the battery pack when the scooter is charging or with the key in the ignition. Make sure **not to unfold the handle before pulling the pack out** (unfold it after the battery has been removed from the scooter).

The wheels and base of the pack slide out and fold up automatically when you remove it or insert it into the scooter. **Nevertheless, it is your responsibility to do this slowly and to make sure the wheels and base come out properly, and that when inserting it, to ensure it is properly anchored** (check before driving).

Whenever the battery is not in the scooter, the part of the (*Multicontact*) connector that is on the scooter must be covered with the rubber cap designed for this purpose. The goal is to protect it while it is disconnected:

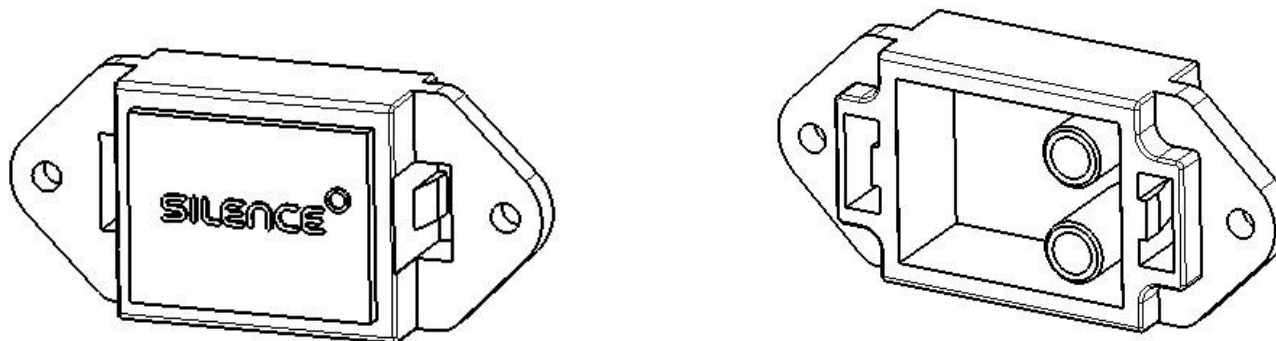

WARNING: do not put the protective cap on while the scooter is plugged in and never get the connector wet (even with the cap on).

c) Fuse box

The fuse box is located under a protective lid, inside the seat compartment:

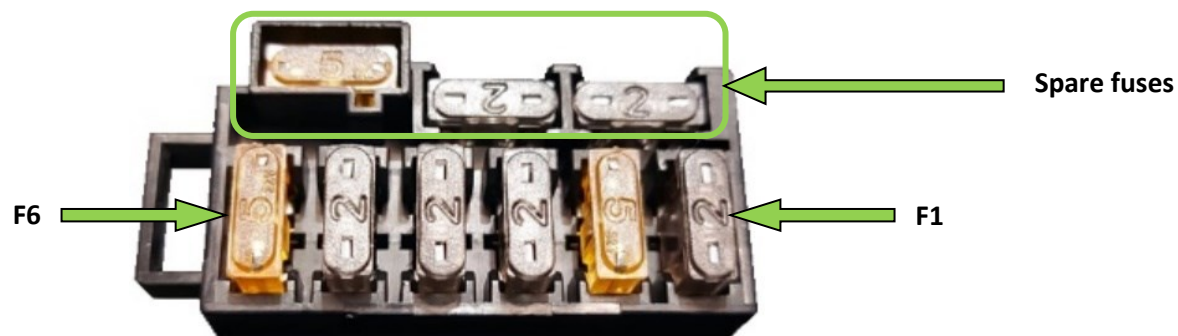

The scooter has **6 fuses**, from right to left in the image (or from rear to front, with respect to the direction of travel):

- **F1 (Grey/black)**: 2A fuse to protect the USB port.
- **F2 (Orange/yellow)**: 5A fuse protecting the power source for lights, horn, etc. (12 VDC/VDC socket).
- **F3 (Grey/black)**: 2A fuse protecting the DC/DC converter (60 VDC/VDC inlet).
- **F4 (Grey/black)**: 2A fuse protecting the inverter (MCU).
- **F5 (Grey/black)**: 2A fuse protecting the second 60 VDC/VDC inlet (installed on some versions).
- **F6 (Orange/yellow)**: 5A fuse protecting the second 12 VDC/VDC outlet (installed on some versions).

There are another 3 spare fuses, as shown on the top of the image.

8) Stands

a) Side stand

The side stand is on the left side of the scooter.

To put the side stand down, push the “U”-shaped leg down.

The side stand should be used when the ground is too unstable or on a slight incline, making it impossible to use the centre stand.



b) Centre stand

The centre stand is located at the bottom of the scooter in the centre.

This stand keeps the scooter in a vertical position.

To put the stand down, push the leg down with your foot as you push or pull the scooter gently up or down (we recommend holding the handlebar and rear handle while doing this).

The centre stand should be used when the ground is stable or flat, and for long parking periods or servicing.



9) Rear-view mirrors

Before driving, always make sure both mirrors are properly adjusted to the current driver of the scooter.



10) Accessories

There is a wide range of accessories available to customise your S02 LS, according to your needs: high windshield, two-seater seat (in 1 or 2 pieces), load carrying accessories, such as top cases and bags, with a different storage capacity, *smartphone* support, rear footpegs, etc. **Check the official website for more information.**

TECHNICAL SPECIFICATIONS

1) Scooter specifications (chassis + motor)

SCOOTER					
CHASSIS					
Construction	Steel tubes				
MAIN DIMENSIONS					
Total length	1968	mm	Wheelbase	1429	mm
Total width	770	mm	Seat height	773	mm
Total height	1072	mm			
MASSES					
MAM: Maximum Authorised Mass	282	kg	Weight of vehicle without battery	89	kg
MAM front axle	111	kg	Weight of the vehicle with a battery (2 kWh / 5.6 kWh)	117 / 130	kg
MAM rear axle	172	kg	Weight of the battery (2 kWh / 5.6 kWh)	28 / 41	kg
FRONT WHEEL ASSEMBLY			REAR WHEEL ASSEMBLY		
FRONT WHEEL			REAR WHEEL		
Front rim	13"		Rear rim	12"	
Front tyre	120/70-13		Rear tyre	120/80-12	
Front tyre pressure (solo/with passenger)	2.2 / 2.4	bar	Rear tyre pressure (solo/with passenger)	2.3 / 2.6	bar
FRONT BRAKE			REAR BRAKE		
Type	Disc (hydraulic, combined)		Type	Disc (hydraulic, combined) + Regenerative	
Diameter	220	mm	Diameter	180	mm
FRONT SUSPENSION			REAR SUSPENSION		
Type	Conventional hydraulic telescopic fork		Type	Double side hydraulic shock absorber (adjustable, 5 positions)	

Travel	80	mm	Travel	63	mm
POWER TRAIN					
MOTOR					
Type	Brushless, on the wheel. Reversible: regenerative motor brake. Reverse gear				
Nominal power	1.6	kW	Maximum vehicle speed	45	km/h
Peak power	2.2	kW	Power/mass ratio	0.018	kW/kg
ENERGY EFFICIENCY					
With BP 2 kWh			With BP 5.6 kWh		
Energy consumption	55	Wh/km	Energy consumption	55	Wh/km
Environmental regulations	Euro 5	-	Environmental regulations	Euro 5	-
Range (BP 2 kWh)	52	km	Range (BP 5.6 kWh)	149	km

2) Battery and charger specifications

DISCLAIMER

The battery can be a **VERY DANGEROUS** (life-threatening) product when it is not on the scooter:

- It should always be transported on its wheels, slowly (max. 3 km/h), slower than the average person walks.
- Be very careful with the battery, avoid hitting or bouncing it, rolling it over cobblestones, stairs or holes, or dropping it (down stairs, for example), as this could cause it to catch fire. Avoid all contact with water.
- If there is any indication or you suspect the *battery pack* has been used improperly or has fallen, do not plug it in. Call a SILENCE Official Service Centre, as this could be **LIFE-THREATENING**.

A battery fire can be put out with water, a CO₂ fire extinguisher or class D fire extinguisher, unless the battery is plugged in or near other batteries. In this case, use a CO₂ fire extinguisher or class D fire extinguisher to put out the fire and take it to a safer, more isolated location (at least 15 m from any exposure: other vehicles, batteries, etc.). Once in a secure location, call emergency services to take control of the situation.

There are 2 different battery models for this scooter model, with the technical specifications shown below:

BATTERY SPECIFICATIONS		
Nominal capacity	2 kWh	5.6 kWh
Cell chemicals	Lithium-ion cells	
Weight	28 kg	41 kg
Unfolded height	870 mm	
Box height	270 mm	
Wheel width	330 mm	
Box depth	440 mm	
Nominal voltage of the battery	51 VDC	
Storage temperature (no charge)	-20 to 45°C (max.) / 0 to 25 °C (recommended)	
Operating temperature	0 to 45°C (charging) / -10 to 60°C (use, discharged)	
Housing material	Aluminium and PC	
Max. charging current	20 A	35 A
Max. discharge current	80 A	280 A
Charger type	Onboard 90-240 VAC; 600 W	
Standard charge time	3-4 h	7-9 h

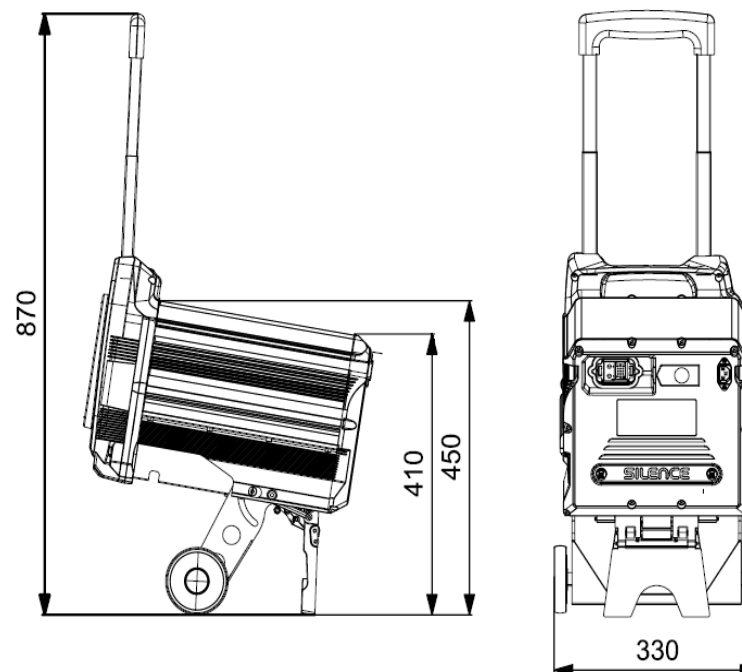

BATTERY PACK

1) Components

The SILENCE S02 LS model has an innovative removable battery pack which, in addition to its basic internal systems, also has the following elements:

a) *Trolley-type removal system*

This system includes an extendible handle, two wheels and a support base (to use on flat, horizontal surfaces). To learn more about how to remove it from the scooter, see the “**Removing the battery**” section.



b) *Internal charger*

Integrated into one of the side covers, the internal 600 W charger allows the battery to be charged on the scooter or when removed, using any conventional plug (Schuko) with a Schuko to IEC cable adapter (supplied with the scooter):

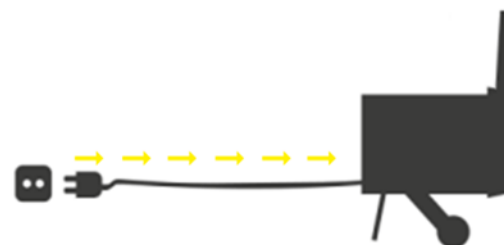

c) Light ring

Information on the battery charge level is available, whether or not the battery is in the scooter, on an LED light ring on one side of the battery pack. Just touch the inside of the ring lightly for the following information:

NOT CHARGING: when you touch the centre of the ring, it will show red and blue light trails, each moving around the ring in opposite directions. Following this, it will be shown in turquoise, and then the remaining charge will be indicated as a portion of the ring lit up in green (or the whole ring if the battery is 100% charged). When the battery charge is low, the entire ring will be shown in red.

CHARGING: while the battery is charging, a green light trail moving around the ring will alternate with a portion of the ring lit up, showing the percentage of the battery that is charged. When it reaches 100%, the ring will be all green with a blue light trail moving around the ring while it is plugged in.



(The model shown may not correspond to the model described in the manual)

If the scooter ignition is on, the ring will not light up under any circumstances.

2) Energy

With our removable battery system on the S02 LS model, we have created a series of parts to give our batteries additional uses. It is not just about getting around the city on your electric scooter and being able to charge it wherever you want, whenever you want. Now, you can also use it to power many other devices.



- **Energy IN:** You will find the power to charge the battery pack, which at SILENCE we call “Energy IN”. You can charge your battery in our quick charging cabinets or by plugging it directly into a normal socket
 - ➔ (**WARNING:** only use the quick charging devices supplied by SILENCE to ensure the validity of the warranty*.)
- **Energy OUT:** Moreover, “Energy OUT” is for everything that can be powered using the battery, i.e. all the applications of the battery pack: power for your S02 LS or other models, or for your computer, television, camping stove, coffee maker or microwave, for example.

Anything that needs electric power can be plugged into the **Inverter** that SILENCE has developed to adapt the voltage to 700 W and power everything you use. Simply connect the **battery pack** to the **inverter**, which converts the voltage from 60V to 220V. It has 2 power points where you can plug in any electronic device or appliance, wherever you are (according to the power limits). **Available soon.**



3) Exchanging batteries (*available soon*)

You will soon be able to use the *SILENCE Battery Station* to exchange batteries. You can reserve a charged and available battery through the SILENCE APP (<https://www.SILENCE.eco/conectividad/>), and exchange it for your battery with a low charge, wasting no time on charging batteries. **Only for purchase with battery hire.**



4) Battery management system (BMS)

This battery has a **BMS** (*Battery Management System*), which controls parameters such as temperature and voltage. It was developed by the SILENCE R&D team and plays a very important role in balancing the individual charge of each cell and the overall charge of each series of cells, making sure the battery works at an optimal level.

This system also provides information on the charge level and sets protocols for charge and discharge currents. It also includes an action plan in case of an irregular battery status, triggering preventive measures in case of power, voltage or temperature spikes or losses, etc.

In short, the BMS is the battery's "brain", ensuring optimal performance and safety.

5) Connecting the charging unit

You can charge your S02 LS battery on the scooter or separately. Both the scooter and the battery have an IEC male contact for the power cable. The cable has a female IEC terminal contact and a male Schuko terminal (commonly used in Spain to connect to the domestic network), and is normally stored in the compartment under the seat, where the male connector is located. On the battery, it is located on the back:



Before removing or putting the battery pack on the scooter, make sure it is not charging and that the key is not in the ignition.

The charger (600 W) is part of the battery pack, so all you need to charge the battery is a mains power point and the power cable. It uses convection cooling.

- **To connect**, first plug in the IEC connector (scooter or battery) and then plug it into the mains. It is important to fully charge the battery after it has been partially used 3 or 4 times.
- **To disconnect**, first unplug it from the mains and then unplug the IEC connector. The charging process can be stopped at any time. Also, the control system will stop charging the battery when it reaches 100%.

If the battery temperature is below **0°C** or over **45°C** (due to improper use), it will not charge.

IMPORTANT!

Charge the battery fully once every 30 days to ensure the validity of the warranty*.

If it is connected while it is at a low temperature, an internal heater will be switched on, so the battery will not be connected until it reaches a temperature of 15°C (**in the case of battery units with this element activated**). This heater works when plugged into the mains and allows the power to be transferred at the right temperature. However, this has an impact on the charge time, which will take longer than if the temperature conditions were within the normal range.

For cold regions and seasons, we recommend keeping the battery plugged into the mains so the heater can warm the cells and keep them at the right temperature for the scooter to be used normally.

***To ensure the validity of your battery's warranty, you must charge it fully (to 100%) at least once a month.** If you know you will not be using it for a while, it is important to leave the battery with enough charge so that it doesn't reach critical levels. Batteries that fall below a certain level of voltage no longer work on their own, meaning they cannot be charged and must be taken to an Official Service Centre.

6) Temperature

This scooter has a system that controls and stabilises the voltage and temperature of the cells. To avoid critical situations, the safety systems limit battery use if the cell temperature exceeds safe levels due to overheating or overcooling.

- The battery's operating range is between -10° and 60°C. The performance of the lithium cells may vary depending on the temperature.
- The charger will not charge the battery if the cell temperature is below 0°C or above 45°C.
- The current battery temperature is shown on the scooter *display*. If any of the limits are surpassed (upper or lower, warning or failure), the following light will come on:



Temperature indicator. It flashes when a component is approaching its permissible (upper or lower) limit. It stays on when it exceeds it.
Motor: 100°C (int.), 110°C (fix.). Inverter: 70°C (int.), 80°C (fix.). Battery: 50°C (int.), 60°C (fix.) / 5°C (int.), -10°C (fix.)

Depending on the situation, the following actions should be taken:

- **-Low temperature:** The battery will not function in optimum conditions; store it in a warmer place and charge it (if you have an internal heater on).
- **-High temperature:** The battery cannot deliver more power, due to intensive use; stop the vehicle if needed to cool the battery down.

7) Battery charge level, in % (SoC)

To get as precise a reading as possible for the state of charge (**SoC, in %**) , make sure that the battery is charged up to 100% of its capacity (at least after 3 or 4 partial charging processes).

8) Range

The range of an electric vehicle is the distance it can travel on a single charge of the battery.

This is influenced by many factors, including driving style, scooter load (kg) and distribution, tyre pressure or adverse weather conditions, such as wind, which can reduce the range.

The *display* shows an estimated number of kilometres (or miles) left. This is **approximate** and depends on the driving mode (**CITY/ECO**) and current use of power.

9) Best practices to ensure proper battery maintenance

The battery has a maximum service life of 1,000 cycles, maintaining 80% of its capacity if it is maintained at the correct maintenance intervals and a series of recommendations are followed:

- Make sure that the battery is not fully discharged; charge it when its charge level is at around 25% of the SoC, avoiding fully charging cycles and limiting the depth of discharge.
- Keep the battery at a temperature of 20-30°C and ensure that the battery operates outside this range for as little time as possible. The battery will deteriorate faster when it is operated outside this temperature range and lose its properties.
- If possible, use the internal charging system and try not to use quick charging systems.

10) Safety information regarding the battery

WARNING



NEVER OPEN THE BATTERY BOX

THIS MAY BE HIGHLY DANGEROUS AND WILL TOTALLY VOID THE WARRANTY.

ONLY AUTHORISED PERSONNEL MAY WORK ON THE BATTERY BOX.

IN THE EVENT THAT SMOKE STARTS TO COME OUT OF THE BATTERY, IT IS ESSENTIAL TO URGENTLY CALL THE FIRE BRIGADE (DANGER OF DEATH) AND REMOVE IT FROM THE ENCLOSED SPACE IN WHICH IT IS LOCATED.

THE VEHICLE CANNOT EXPLODE, SO THERE IS NO PROBLEM IN TRANSPORTING IT TO A SAFE LOCATION

WARNING



TO PREVENT INJURIES, BURNS OR ELECTRIC SHOCKS:

- NEVER DISASSEMBLE THE BATTERY UNIT OR REMOVE ITS CAPS. ONLY AUTHORISED PERSONNEL ARE PERMITTED TO DO SO.
- KEEP CHILDREN AWAY FROM THIS PART OF THE SCOOTER.
- DO NOT PERFORATE OR KNOCK THIS AREA WHEN USING HOISTS, DO NOT EXPOSE IT TO FLAMES, INCINERATE IT OR EXPOSE IT TO LIQUIDS, AS THE GENERATION OF EXCESS HEAT MAY LEAD TO FIRE, WHICH COULD BE VERY DANGEROUS.

QUALIFIED AUTHORISED PERSONNEL

YOU MUST READ THE WORKSHOP MANUAL BEFORE REPAIRING OR REPLACING THE BATTERY.

a) First aid measures

In the case of a broken battery, smoke or fire, evacuate people from the contaminated area and provide as much ventilation as possible to clear out the gasses. Seek medical attention.

- Contact with eyes: flush with water (eyes open) for at least 10 minutes.
- Contact with skin: remove contaminated clothing and flush the affected area with soap and water for at least 15 minutes. Do not apply grease or ointments.
- Inhalation: take outdoors and ventilate the contaminated area. Provide oxygen or artificial respiration if necessary.

b) Fire protection measures

Extinguishing measures:

- The following can be used: D-type, CO₂ and dry chemical extinguishers. Water if the scooter/battery is not connected to the mains or near other batteries.
- Specific hazards: cells overheating due to external heat sources or improper use.

DISPOSAL AND RECYCLING

1) Recycling the battery pack

S02 LS battery packs that have reached the end of their service life must be disposed of in compliance with the applicable regulations and always respecting the environment. The Law prohibits disposing of *battery packs* in domestic waste containers. It must be deposited at an authorised SILENCE Service Centre to ensure it is recycled properly, reducing its environmental impact.

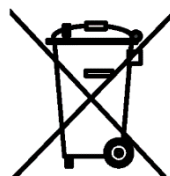

2) Recycling the scooter

When you need to dispose of your SILENCE scooter, you must do so according to the applicable regulations and always respecting the environment. For more information about recycling and disposal of your scooter, please contact an authorised SILENCE Service Centre, which will provide you with the guidelines for proper disposal of the scooter and all of its components at the end of its service life.



MAINTENANCE SCHEDULE

As with any other vehicle on the road, regular maintenance and inspection is required before each use. This is the only way to ensure your own safety and that of others on the road, while also guaranteeing an optimal experience on the scooter.

Always take your scooter to a SILENCE Official Service Centre, as they know your scooter best and have the right tools to diagnose and repair it. However, there are some things you can (and should) check yourself, such as tyre pressure, brake fluid level, etc.

DISCLAIMERS

- These instructions were drafted for owners that will only use the S02 LS in urban areas. If you use it for a purpose other than that for which it was intended or constantly drive at a high speed or in overly damp or dusty conditions, you will have to service the scooter more often. Always read the instructions before starting and make sure you have all the materials you need and a clear idea of what you are going to do.
- If your S02 LS is involved in an accident, request an inspection of the main components by a SILENCE Official Service Centre.
- Failure to properly maintain the scooter, correctly follow instructions or resolve a problem before driving could cause an accident in which there is a **SERIOUS RISK OF INJURY OR DEATH**. Always follow this schedule and any advice from your SILENCE distributor.
- There are some basic operations you may be able to do on your own (those that are the same for a combustion engine motorcycle, such as, for example, changing the brake pads). Only you can decide if you are capable and, therefore, whether or not you should carry out said task personally.
- Use the centre stand for any operations, always on a flat, hard horizontal surface.
- Always carry out any operations on the scooter when it is turned off and with the keys removed (unless indicated otherwise in the instructions), to avoid starting it accidentally and having an accident with the motor running.
- Take care with hot parts, above all the disc brakes just after driving your S02 LS. Let them cool down first.

1) Operations and frequency

ZONE	WHAT TO DO	FREQUENCY
Painted parts	Clean with shine restorer.	Every month
Rubber parts	Clean with special products to protect the rubber.	Every month
Aluminium parts	Clean with protective spray to prevent rust. Remove any rust on the aluminium carefully with steel wool and soap.	Every week
Metal parts	Use oil to clean and lubricate metal parts (in particular, the battery undercarriage, to guarantee that it can be mounted correctly on the undercarriage).	Every month
Seat	Clean with a soft sponge to remove any insects or dirt.	Every day of use
Dashboard	Clean any hardened dirt with a soft sponge.	As needed
Tyres	Make sure that the pressure is as indicated in section “Scooter specifications (chassis + motor)”.	Every week
Lights	Clean any hardened dirt with a soft sponge.	As needed
Display	Clean with a soft sponge to remove any insects or dirt.	Every day of use

2) Cleaning

Clean the scooter as indicated in the previous section. As with any vehicle, it is important to clean it regularly to keep it in good condition. It is the user’s responsibility to properly protect the scooter from aggressive contaminants in the air and the effects of salt on the roads.

WARNING: Do not clean the battery with a lot of water or a high-pressure washer. Never use harsh detergents on the scooter. Try to find gentle cleaning products for the vehicle that are environmentally friendly.

When you dry your scooter, always use a clean and smooth cloth. Dirty or rough cloths can scratch the flat, shiny surfaces and clean and smooth ones will reduce scratching. Never use hard cloths or sponges.

3) Storage

If you are not going to be using your scooter for a long period of time, read and follow these instructions:

- Clean the scooter and let it dry **completely** before storing it. Any traces of water could cause contact problems on the electronic components.
- Make sure the scooter is supported by its **centre** stand.
- Check the scooter to make sure there have not been any problems in the past.
- A **cover** protects your scooter from the elements and is a good investment.
- Put some kind of **protection** on the floor to protect from any leaks.

4) Checks before driving

c) Charge level

Check the charge level on the LCD screen. If it is too low, recharge the battery before using your scooter:

d) Lamps and indicator lights

Replace any parts that don't work properly or have been damaged before driving. When the speedometer lights do not work properly, they start flashing more quickly to indicate that there is some sort of problem.

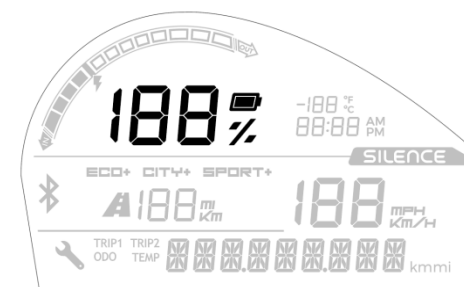

e) Stands

Make sure both the side stand and centre stand are folded away. The side stand has a sensor that prevents the scooter from being driven when it is out, but the centre stand does not.

f) Tyres

Always make sure there are no punctures, cracks or tears in the tyres, and that the treads are not worn down. Never drive with worn or defective tyres. Refer to section “**Scooter specifications (chassis + motor)**” for more information about the correct inflation pressures of your scooter’s tyres. Driving with the incorrect tyre pressure can damage the tyre and cause an accident, as well as reduce its lifespan.

Rear tyre

It is very important to ensure the correct pressure levels on the rear tyre, since the motor is housed inside this tyre.

It is important to remember that this vehicle has more weight on the rear wheel than conventional vehicles (those without an in-wheel motor), so the rim or motor can be affected when going over kerbs, potholes or road humps if travelling at the same speed as a conventional vehicle.

WARNING: If you go over kerbs, potholes or road humps at high speed, you could damage the vehicle’s rim and/or motor.

g) Brakes

Brake fluid

The brake fluid tanks are located on the top of the handlebar, one on each side. Check the levels with the scooter resting on both wheels, not on either stand.

The brake fluid should never fall below the MIN line on the tank. Air can get into the tank if it is empty, which can cause problems in the scooter’s brake system and compromise safety when driving.

Levels should always be checked and the fluid must be changed every 2 years. If there is not enough, add more DOT4 brake fluid.

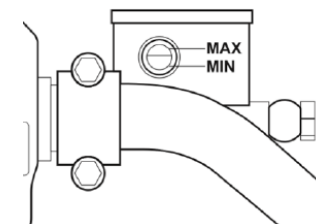

WARNING: brake fluid can damage the scooter's paint and plastic parts if spilled.

Brake fluid can cause damage and injuries if not handled properly and safely.

If you get brake fluid on your skin, wash it off immediately with water. If you get brake fluid in your eyes, rinse them with water and seek medical attention quickly.

Brake pads

When the brake pads are less than 1 mm thick, they are less effective. Consult your point of sale for replacements.

Brake levers

If there is too much play on the brake levers, but the brake pads are still in good condition, take the scooter to the official point of sale as soon as possible to have it checked:

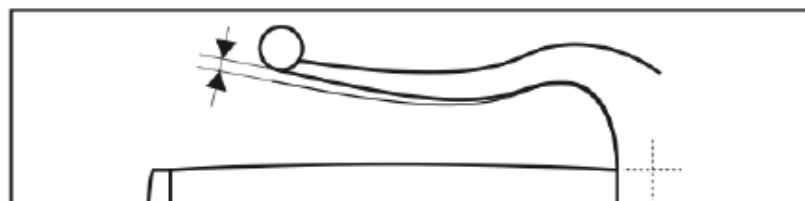

After the “D” icon lights up (scooter ready to drive), make sure that the braking system is working properly: squeeze the left and right brake levers at the same time to make sure there is resistance to the pressure on both.

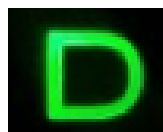

Adjusting the brake lever

The position of the left and right brake levers can be adjusted for greater driving comfort. The adjustment device is mounted on the brake levers.

Rotate the adjustment device forwards or backwards to adjust the position of the brake levers.

WARNING

The brake lever adjustments only affect the lever position and have no effect on the braking power or range.



TROUBLESHOOTING

For the faults described here, it is assumed that only the final components are the cause of the problem. If the problem persists after replacing the final component, take the scooter to the official point of sale.

All of our scooters are examined carefully before they are sent to our distributor. Incidents may appear after the scooter is inspected. The following table offers guidelines for identifying the problem and, if possible, repairing it yourself. If you cannot solve the problem, take the scooter to the SILENCE Official Service Centre, so it can be inspected and repaired if needed.

INCIDENT	PROBABLE CAUSE	SOLUTION
A light/lamp is not working (headlight, tail light, indicator lights)	Damaged fuses. The component is defective or the connectors are damaged.	Check the fuses and connectors, and if the problem persists, take the scooter to the nearest official distributor
The scooter does not accelerate	Throttle not adjusted properly.	Check the connection between the throttle and the electrical installation. Take the scooter to the nearest official distributor
The scooter will not start	Key not in the ignition The scooter is charging The battery is dead Damaged fuses	Check that the key is in the ignition Wait for the battery to charge and disconnect the charger Charge the battery fully Replace damaged fuses If the problem persists, take the scooter to the nearest official distributor
The battery will not charge. Battery percentage does not increase	Problem with the battery, problem with the charger Power is not getting to the charger	Check the scooter-battery and scooter-mains connection (charging the battery in the scooter) Check the scooter-mains connection (charging the battery outside the scooter)
The brakes do not work properly	Incorrect tyre air pressure The tyres are worn Excessive or incorrectly distributed load	The air pressure must be checked and adjusted accordingly (as indicated in section "TECHNICAL SPECIFICATIONS") Replace the tyres Check to see whether the load is excessive. Reduce or redistribute the load
Error in the state of charge (SoC)	The charge gauge is not synchronised with the actual state of charge	Charge the battery fully If the problem persists, take the scooter to your nearest official distributor.
Message on screen: "0x..."	Depends on the problem	Contact your nearest official distributor.

VEHICLE AND BATTERY WARRANTY

1) Delivery to buyer

This document is the basis for processing any warranty claims (warranty claims cannot be processed if the documents are not filled in properly or are incomplete):

VIN (Vehicle Identification Number)	
Full name Address City/Town Postcode Country Telephone / Mobile phone e-mail Date of delivery
	Distributor number

2) Warranty terms and conditions (grounds for voiding the warranty)

As a general rule (*), this vehicle has a two-year warranty (except special promotions offering a three-year warranty), from the date of delivery and reception, covering any design and manufacturing defects.

Parts subject to normal wear and tear, such as tyres, disc brakes, brake pads, etc., are not covered by this warranty. The manufacturer and the chosen garage will decide which defective parts will be replaced or repaired.

The warranty will be VOID if:

- a) The end user has not followed the regulations when handling the vehicle.
- b) The end user has not carried out any or has only carried out some of the inspections required in the service booklet or has taken the scooter to be repaired at a garage that is not authorised by the manufacturer (see the “**Inspection: Scooter and battery**” section).
- c) The vehicle has been modified or changed in any way, or fitted with parts that are not among the original features certified expressly by the manufacturer (provided that the problem is associated with the modification).
- d) The vehicle has been used in sporting competition.
- e) The operations, maintenance and service instructions set out in this manual have not been followed.

WARNING: Normal use, definition: At least once a week, for a minimum of 10 hours.
Normal use - > The scooter should be fully charged before it is left parked for more than one week.

The battery must be charged fully once every 30 days to ensure the validity of the warranty.

TECHNICAL NOTICE: Silence vehicles feature an internal communication bus (CAN bus), which is used by all electronic devices to communicate and ensure proper functioning of the vehicle: Electronic Control Unit (ECU), Battery Management System (BMS), Motor Control Unit (MCU) Telematics Control Unit (TCU), among others.

It is expressly prohibited to connect to and communicate via any device through the CAN bus, since this might alter the operation of the vehicle, affect the product quality, entail a risk to the vehicle's safety and void the warranty.

(*) Any agreements that differ from the warranty terms and conditions above must be confirmed in writing by the manufacturer.

3) Inspection: Scooter and battery

Each S02 LS must pass a series of regular inspections, based on the kilometres travelled or at least once a year (if the scooter has not travelled the kilometres necessary to require an inspection within a year). The same is true for the battery packs (*be*), which have their own inspection intervals. For batteries purchased with the scooter, the inspections will be the same as for the scooter and must be passed at the same time.

The number of kilometres between inspections **of the scooter and battery** is shown automatically on the scooter's *display* (the screen will show a spanner icon to indicate that it is time for an inspection based on the kilometres travelled) and is as follows: first inspection at **1,500 km**, second at **5,000 km**, third at **10,000 km** and subsequent inspections **every 5,000 km**.

Inspections of the **scooter** must be carried out within one year of the previous inspection (**at least one per year, the first one 3 months after purchase**).

Information on what to inspect is provided in the corresponding manual/maintenance schedules for the scooter and the battery, which are available to SILENCE Official Service Centres.

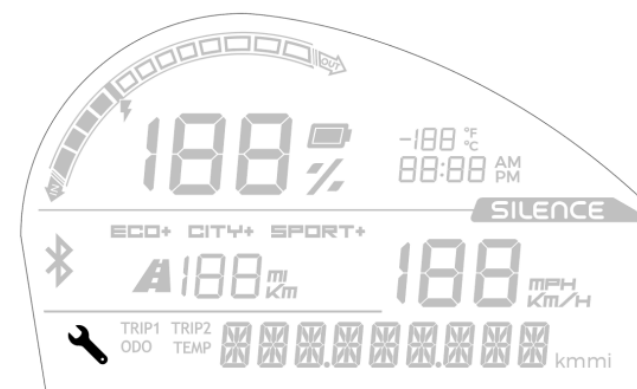

S02 LS inspection log (both scooter and battery):

INSPECTION No.	DATE	ODOMETER READING	OFFICIAL SERVICE SIGNATURE
NUMBER PLATE/...../.....		
1st INSPECTION BEFORE:	+3 months ↓/...../..... or/...../.....	1,500 km km	
	must be greater than ↓	must be greater than ↓
1st INSPECTION INFO:/...../.....km	
NEXT INSPECTION BEFORE:	+1 year ↓/...../..... or/...../.....	+5,000 km ↓ km	
	must be greater than ↓	must be greater than ↓
2nd INSPECTION INFO:/...../.....km	
NEXT INSPECTION BEFORE:	+1 year ↓/...../..... or/...../.....	+5,000 km ↓ km	
	must be greater than ↓	must be greater than ↓
3rd INSPECTION INFO:/...../.....km	
NEXT INSPECTION BEFORE:	+1 year ↓/...../..... or/...../.....	+5,000 km ↓ km	
	must be greater than ↓	must be greater than ↓
4th INSPECTION INFO:/...../.....km	
NEXT INSPECTION BEFORE:	+1 year ↓/...../..... or/...../.....	+5,000 km ↓ km	
	must be greater than ↓	must be greater than ↓
5th INSPECTION INFO:/...../.....km	
NEXT INSPECTION BEFORE:	+1 year ↓/...../..... or/...../.....	+5,000 km ↓ km	
	must be greater than ↓	must be greater than ↓
6th INSPECTION INFO:/...../.....km	
NEXT INSPECTION BEFORE:	+1 year ↓/...../..... or/...../.....	+5,000 km ↓ km	
	must be greater than ↓	must be greater than ↓

INSPECTION No.	DATE	ODOMETER READING	OFFICIAL SERVICE SIGNATURE
7th INSPECTION INFO:/...../.....km	
NEXT INSPECTION BEFORE:	+1 year ↓/...../..... or/...../.....	+5,000 km ↓ km	
	must be greater than ↓	must be greater than ↓
8th INSPECTION INFO:/...../.....km	
NEXT INSPECTION BEFORE:	+1 year ↓/...../..... or/...../.....	+5,000 km ↓ km	
	must be greater than ↓	must be greater than ↓
9th INSPECTION INFO:/...../.....km	
NEXT INSPECTION BEFORE:	+1 year ↓/...../..... or/...../.....	+5,000 km ↓ km	
	must be greater than ↓	must be greater than ↓
10th INSPECTION INFO:/...../.....km	
NEXT INSPECTION BEFORE:	+1 year ↓/...../..... or/...../.....	+5,000 km ↓ km	
	must be greater than ↓	must be greater than ↓
11th INSPECTION INFO:/...../.....km	
NEXT INSPECTION BEFORE:	+1 year ↓/...../..... or/...../.....	+5,000 km ↓ km	
	must be greater than ↓	must be greater than ↓
12th INSPECTION INFO:/...../.....km	

