

SILENCE



Variant shown: S01+

USER MANUAL

S01 *The Ride Decision*

MY23

S01 LS

S01 BASIC

S01 STANDARD

S01 CONNECTED

S01+

(V002)

HELL SILENCER

Introducing your new S01 electric scooter, a model equivalent to a 125 cm³ (or 50 cm³, case LS), designed for urban use and 100 % *Made in Barcelona*.

S01, the electric scooter with the best battery. Created, designed and patented by SILENCE, this is a *trolley-type* removable battery with wheels, which breaks the barriers of charging points, allowing the user to comfortably and safely carry the battery and charge it in any conventional power point: at home, in the office, in a bar... See the “**Best practices for battery charging**” section for more details..

This model is divided into 5 types: **Basic**, **Standard**, **Connected**, **Plus (“+”)** (all with **L3e** homologation) and **LS** (with **L1e** homologation):

- The **Basic** variant has a maximum speed of **80 km/h** and it has a **4.1 kWh** battery, which allows it to reach a range of around **100 km**.
- The **Standard** variant has a maximum speed of **95 km/h** and a range of around **133 km** thanks to a **5.6 kWh** battery. It also has a **USB** power socket, for charging your mobile phone, for example.
- On the other hand, the **Connected** variant, in addition to sharing the features of the **Standard** variant, also has a **TCU** device that, thanks to the “**My Silence**” application, allows you to link the scooter to your smartphone, being able to control it at all times and even **share it** with whoever you want.
- The most advanced version as far as the S01 model is concerned is the **Plus (S01+)** variant,. In addition to all the features offered by the **Connected** variant, it has a number of elements that make it the **top of the range**: adjustable suspensions (front and rear), petal brake discs, an unmistakable aesthetic... and a top speed of **110 km/h**.
- Finally, there is the **LS** variant, which is equivalent to the **Connected**, but limited to **45 km/h** and with a range of **146 km**.

To sum up, a new zero-emission, technological scooter with an attractive design for safe, modern and silent urban driving. The best way to accelerate in the change toward sustainable urban mobility.

Do you accept SILENCE’s challenge to improve our cities?

Before you ride your S01 for the first time, read this User Manual, ensuring your safety and preventing damage to the vehicle or third parties. When necessary, always take your scooter to a SILENCE Official Service Centre for maintenance.

Enjoy smooth riding, with no noises or vibrations. Thank you for choosing a SILENCE S01!

ABOUT THIS MANUAL

Please read the whole manual carefully and pay special attention to the safety instructions. It explains everything you need to know as a S01 driver.

The information in this manual is the most recent that is available for this model as of the date of approval for publication/printing. Scutum Logistic S.L. reserves the right to make changes at any time and without prior notice, without incurring any obligation. In case of discrepancies between the contents of the manual in different languages, the information given in the Spanish version shall prevail. No part of this manual may be reproduced without written authorisation. You can consult the most recent version at [USER MANUALS](#), or by scanning the following QR code:



The images in this manual may show optional accessories installed (not included in standard models), as well as elements with colours that may differ in real life. The variant shown on the cover is the S01+.

FAQ's

If you experience an incident with your S01, first refer to the “**TROUBLESHOOTING**” section.

Furthermore, at the following link you will find answers to some questions you may have (FAQs): [SUPPORT](#). You can also scan this QR code:



OFFICIAL SERVICES NETWORK

If you need additional support, you can always contact a SILENCE Official Service Centre. You may find the map with our service network under the link [OFFICIAL SERVICE CENTRES](#) or by scanning the QR code.



CONTENT OF THIS MANUAL

HELLO SILENCER 2

ABOUT THIS MANUAL..... 3

FAQ’s 3

OFFICIAL SERVICES NETWORK 3

CONTENT OF THIS MANUAL 4

SAFETY 6

 1) Use and maintenance..... 6

 2) Clothing and protection elements 7

 3) Carrying loads..... 8

 4) Accessories and modifications 8

VEHICLE IDENTIFICATION..... 9

 1) VIN number - Chassis number 9

 2) Production information label 9

BASIC COMPONENTS AND FUNCTIONING10

 1) Battery pack (“be”)..... 11

 2) Motor (real wheel) 11

 3) Dashboard 12

 4) Vehicle control and driving elements..... 20

 5) Ignition 26

 6) Lighting..... 27

 7) Seat - Compartment under the seat 29

 8) Suspensions..... 34

 9) Stands..... 35

 10) Rear-view mirrors..... 35

 11) Accessories 35

DRIVING MODES.....36

“MY SILENCE” APP (ONLY FOR CONNECTED VERSIONS)39

TECHNICAL SPECIFICATIONS40

 1) Scooter specifications (structure + motor)..... 40

2) Battery and charger specifications	42
BATTERY PACK.....	44
1) Components	44
2) Energy.....	46
3) Exchanging batteries	47
4) Battery Management System (BMS).....	48
5) Connecting the charging unit	48
6) Temperature	50
7) Battery charge level, in % (SoC)	50
8) Range.....	51
9) Best practices for battery charging	51
10) Best practices to ensure correct battery maintenance	52
11) Safety information regarding the battery	53
DISPOSAL AND RECYCLING	55
1) Recycling the battery pack	55
2) Recycling the scooter	55
MAINTENANCE SCHEDULE	56
3) Operations and frequency	57
4) Cleaning.....	57
5) Storage	58
6) Checks before driving.....	58
TROUBLESHOOTING	62
VEHICLE AND BATTERY WARRANTY	63
1) Delivery to buyer	63
2) Warranty terms and conditions (grounds for voiding the warranty).....	64
3) Inspection: Scooter and Battery.....	65

SAFETY

Driving a vehicle requires your full attention and can affect your own safety and that of others. You are therefore responsible for taking any precautions necessary to minimise risks when using your SILENCE S01.

This section in particular, and the manual in general, provides **information and recommendations** to make driving your scooter as safe as possible. However, it cannot take into account or warn you of all of the **dangers associated with driving a vehicle** and the maintenance thereof, which is why you must use **common sense** to enjoy your scooter with minimum risk. The most important recommendations are set out below:

1) Use and maintenance

SILENCE S01 is an urban scooter designed to be used only on roads, carrying at most the driver and one passenger. It is also important to respect the maximum load indicated in the "**Carrying loads**" section.

Drive within your own limits: Take your personal abilities and the road conditions into account to drive safely. Do not overestimate them and allow for unforeseen events.

Do not drink or take drugs before driving: Your reactions will be impaired and so will your ability to avoid unexpected hazards. Do not let anyone else drive in that condition either.

Consider other factors: Also take other factors into account that affect driving, such as the consumption of some prescription drugs, tiredness or lack of attention.

Properly maintain the scooter: Just as you have to be in good shape to drive, it is your responsibility to check and maintain your scooter before driving, following the instructions in this manual (refer to the "**MAINTENANCE SCHEDULE**" section). Inadequate or no maintenance is a risk factor.

2) Clothing and protection elements

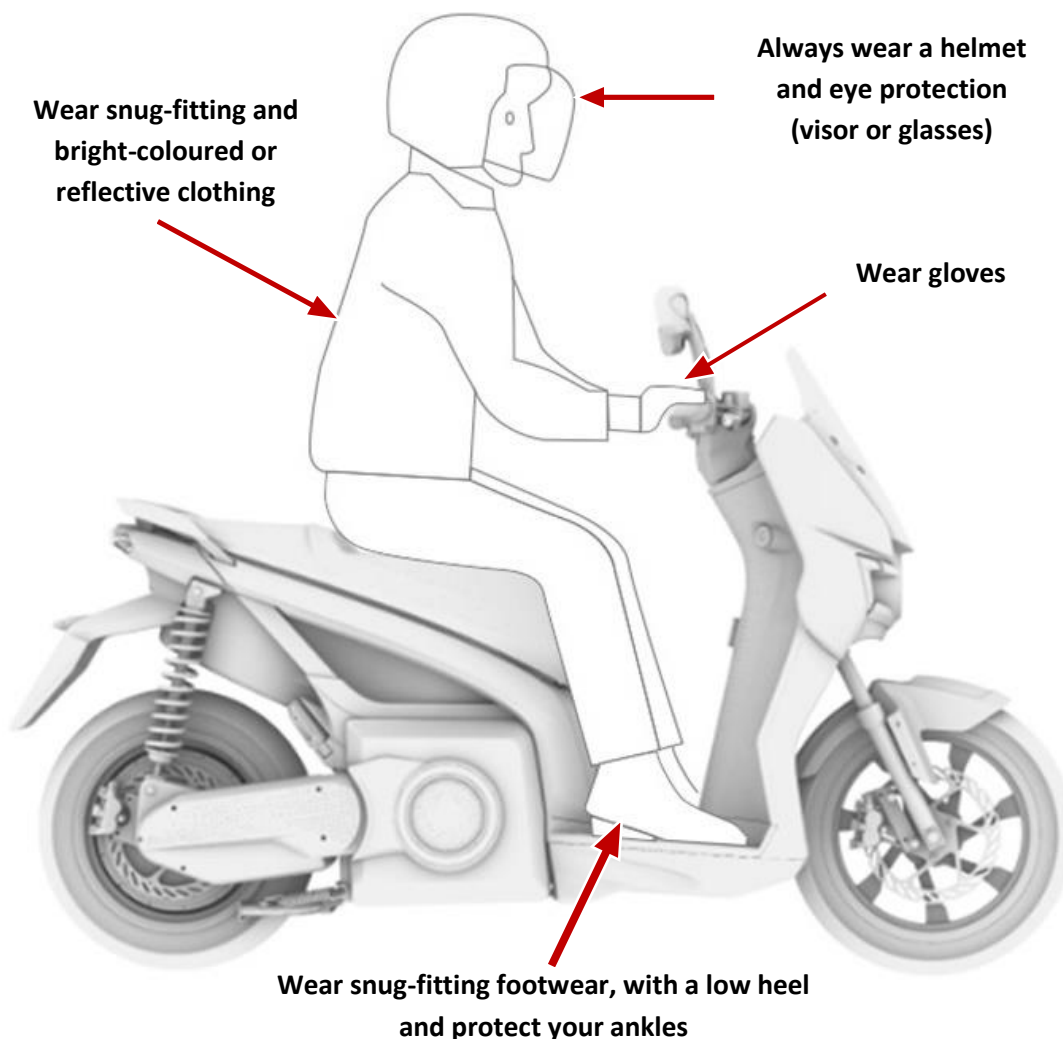

For your safety and that of the passenger, we recommend wearing the right protective clothing when driving the scooter. Although it does not provide total protection, it can considerably reduce the probabilities of injury and the seriousness of the consequences. Consult a specialist to choose the clothing that best suits you.

Always wear a helmet: Proper use of a helmet is basic and obligatory, both for the driver and for the passenger. It must be homologated, in good condition and **fastened properly**. Helmets reduce the number of head injuries and their seriousness. We recommend using **full face** helmets (that cover the whole head) instead of open face helmets (*jet* or three-quarter helmets), in **light, bright colours or with reflector strips**, that are lightweight and **fit properly**.

Protect your eyes: Always use eye protection, either the visor of the helmet or the appropriate glasses.

Other garments: Wear stiff boots and leather gloves to protect your feet, ankles and hands from scratches, cuts and bruises. Wear a suit or jacket and trousers specifically designed for use on a motorbike. These should be form-fitting and the right size, and we recommend they have reflector strips.

These recommendations also apply to any passenger.

3) Carrying loads

This scooter is designed to be driven safely as long as the maximum load capacity and its distribution are respected. Failure to do so may compromise the stability, braking and manoeuvrability of the scooter.

The **maximum weight** of the scooter must not exceed **320 kg**, including the vehicle itself with its battery and accessories, the driver and the passenger (when applicable), and the load. The weight carried must be distributed evenly between the two axles, and must not exceed 102 kg on the front axle nor 218 kg on the rear axle.

Remember that the weight of any accessories installed will reduce the weight of the maximum load that the scooter can carry.

Recommendations

- Distribute the load evenly on the scooter, and try to keep it as close to the centre as possible.
- Make sure the load is firmly strapped down, and avoid carrying loose objects.
- Always make sure tyres are properly inflated, and adjust the rear suspension to suit the specific load in each case.

4) Accessories and modifications

We recommend using only original SILENCE accessories, as they have been designed and tested to ensure they work properly with this model of scooter. If you use other accessories or modify them in any way, you must make sure they are installed and chosen properly, so that they:

- Do not reduce the turning angle of the handlebar or interfere with the use of any of the controls.
- Do not reduce the side angle of inclination or distance to the ground.
- Do not interfere with visibility or the beam of any of the lights.
- Do not tamper with the electrical or electronic components of the scooter.
- Comply with legal regulations.

VEHICLE IDENTIFICATION

1) VIN number - Chassis number

The **VIN** (*Vehicle Identification Number*) is a 17-digit alphanumeric code that identifies your scooter and which is engraved directly on the chassis, on the square section rear bar on the right side, in front of the rear shock absorber. It can also be found indicated on a label under the seat.

The VIN standard is set out in the ISO standard. **The VIN must be given when ordering replacement parts.**

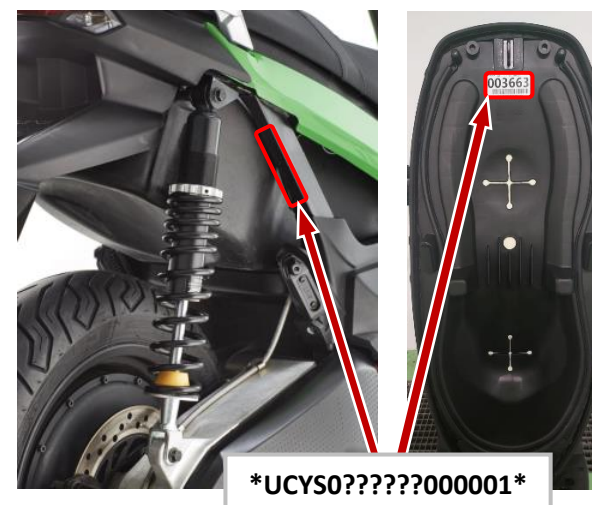

2) Production information label

This scooter has a second label with the chassis and homologation number, among other information.

This label is found on the front part of the battery compartment:

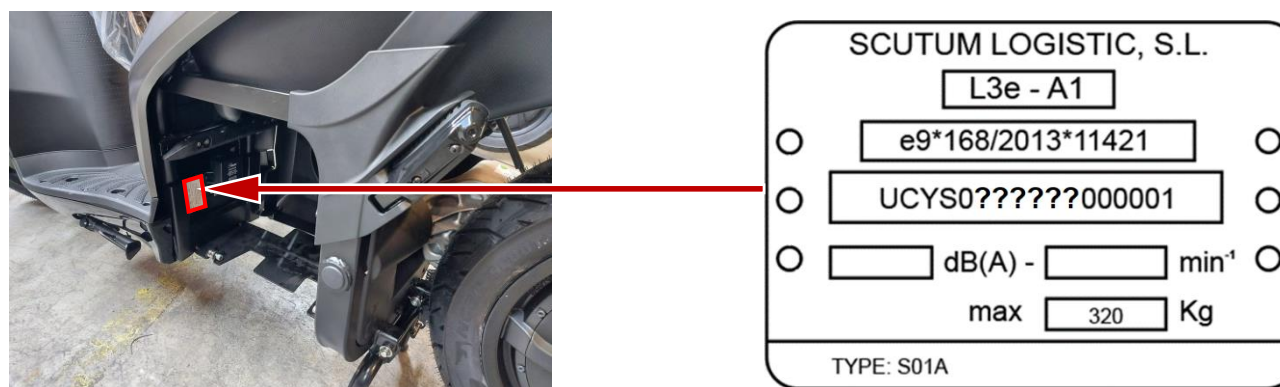

BASIC COMPONENTS AND FUNCTIONING

The basic components (user level) of this scooter are:

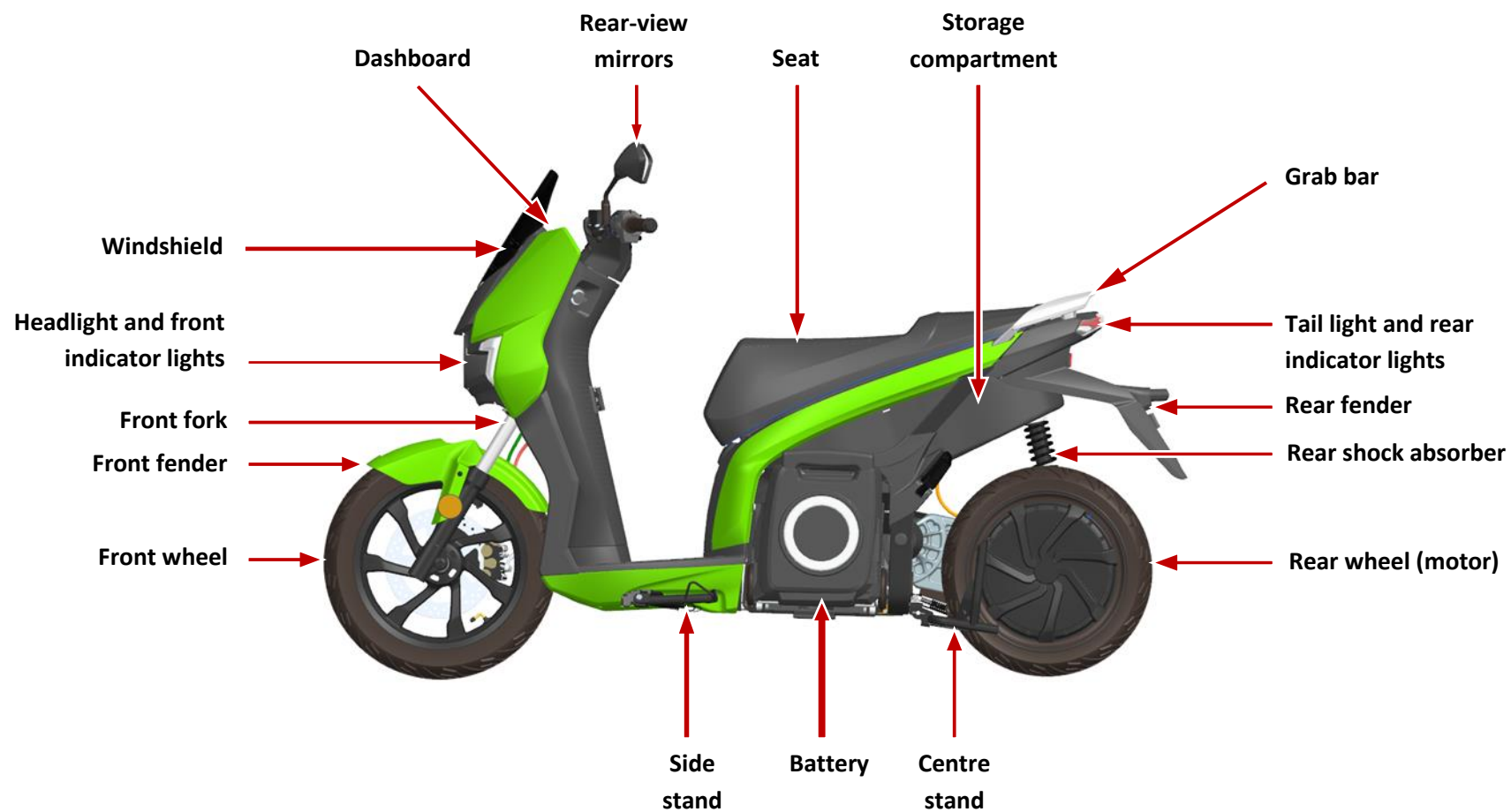

1) Battery pack (“be”)

The SILENCE S01 model has an innovative removable battery pack with a handle and wheels so it can be transported like a *trolley*, called “*be*”. This means you can charge it on the scooter or wherever you want, simply by taking the battery to a power source. This battery pack can also be used on other scooters, or even used to power other devices.

For more information, refer to the “**BATTERY PACK**” section, which describes all the features and functions of your new battery.

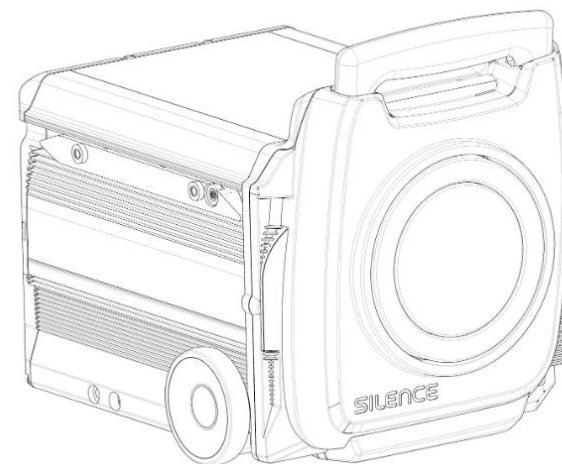

2) Motor (real wheel)

On the rear wheel, this scooter has a **100 % electric motor** with *Brushless* technology, direct transmission and an air cooling system.

In the **Basic**, **Standard** and **Connected** variants, it is homologated with a **nominal power of 7 kW** (being electronically limited to **5 kW** in the case of the **Basic** variant), while in the **Plus** this figure increases to **7.5 kW**.

In the case of the **LS** variant, the homologated power rating is **4 kW**.

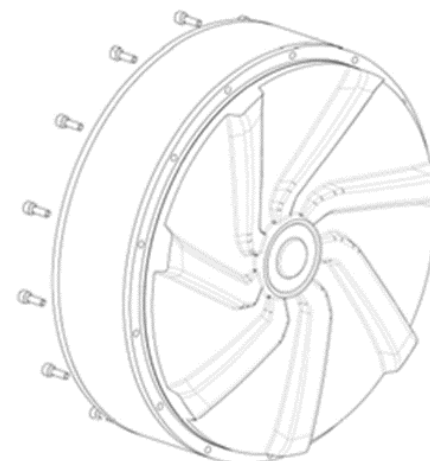

3) Dashboard

The dashboard provides you with all of the information you need about the scooter in order to drive it.

It features an LCD screen, 2 buttons (“SET” and “INFO”) and 10 warning lights, which are explained below.

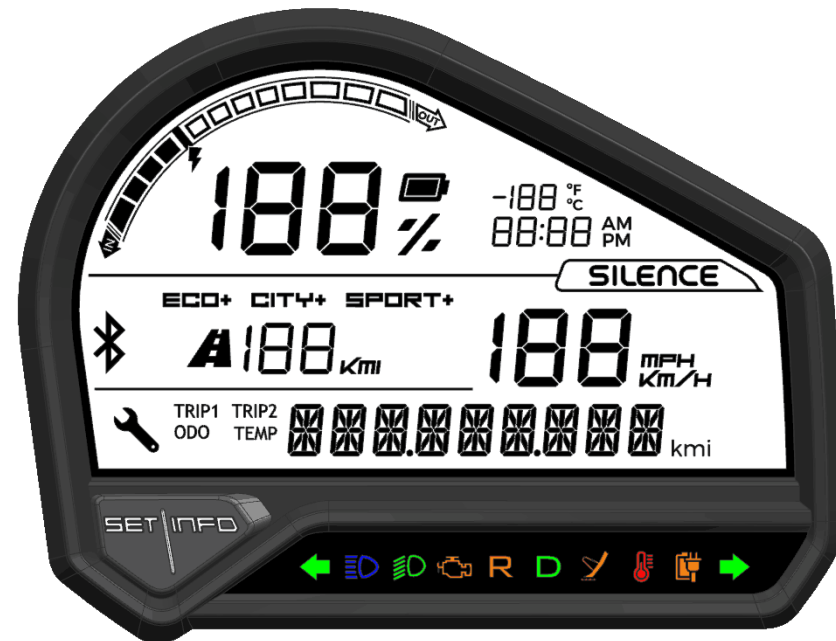

LCD display

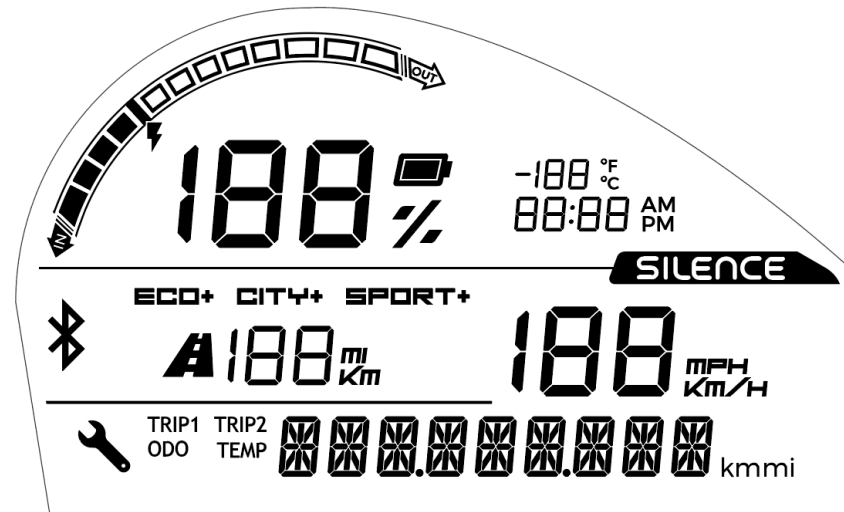

Charge level indicator

The top of the *display* shows the battery's state of charge (**SoC**). This is shown as a percentage, so when the battery is completely discharged it will read 0 % and when it is fully charged it will show 100 %.

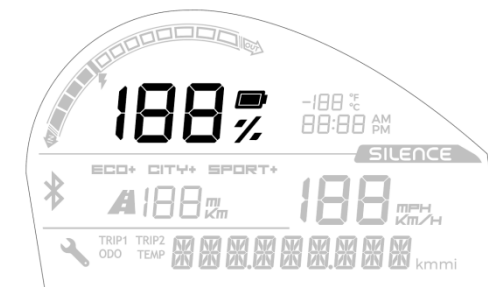

Power light

On the upper left, there is also a light that shows whether power is flowing out of the battery (“OUT”, being used) or into it (“IN”, regenerated through the motor brake or charging).

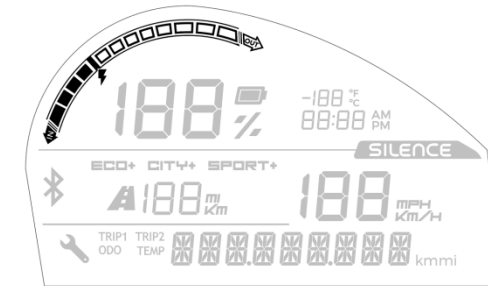

Ambient temperature

On the top right, the ambient temperature is displayed (in Celsius or Fahrenheit, depending on your selection, see **Change Unit System** section). It shows both positive and negative temperatures.

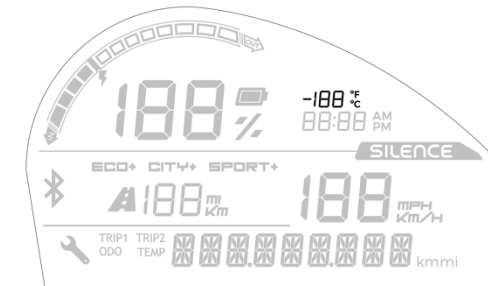

Current time

Just below that, the current time is displayed (battery data). The time can be shown using the 12-hour or 24-hour clock system.

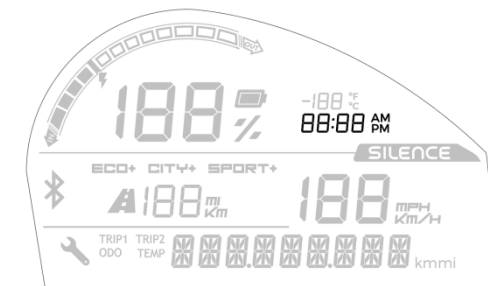

Driving mode

In the top middle area (below the charge percentage), the screen shows the current driving mode (ECO, CITY or SPORT, available depending on the variant).

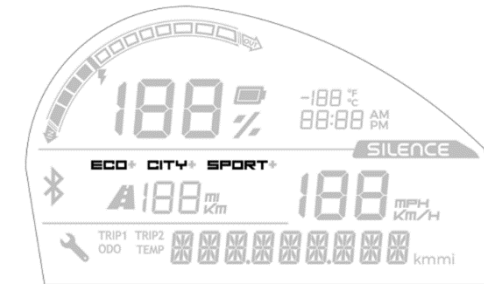

Estimated remaining range

Below the driving modes, there is information about the remaining range, in kilometres or miles. This is approximate and depends on the driving mode and current use of power.

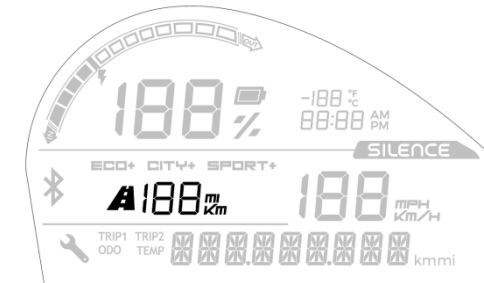

Speedometer

In the middle on the right (under the SILENCE logo), the scooter's current speed is shown. It can be set to kilometres per hour or miles per hour.

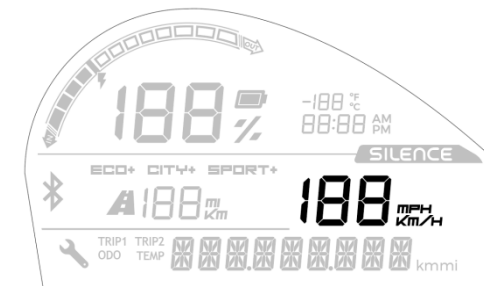

“ODO”

Odometer: indicates the total kilometres/miles travelled.

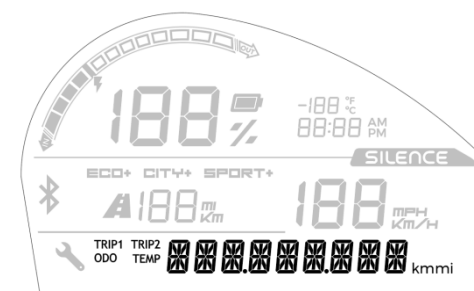

Press **INFO** once to display: ↓

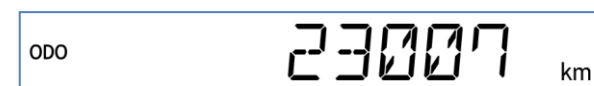

“TEMP”

Temperatures of different components, in Celsius or Fahrenheit.

Holding down the **INFO** button you can switch between:

- TEMP BAT: battery pack temperature.
- TEMP ENG: motor temperature.
- TEMP INV: inverter temperature.

Press **INFO** once to display: ↓

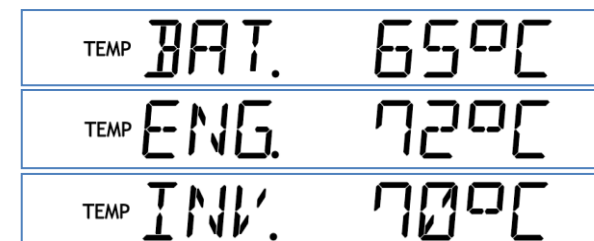

“TRIP1”

Partial odometer 1: indicates the kilometres/miles travelled since the last time it was reset.

Holding down the **INFO** button you can switch between:

- KM/MI: kilometres/miles travelled.
- AVG: average speed for these kilometres/miles (in km/h or mph).

Press **INFO** once to display: ↓

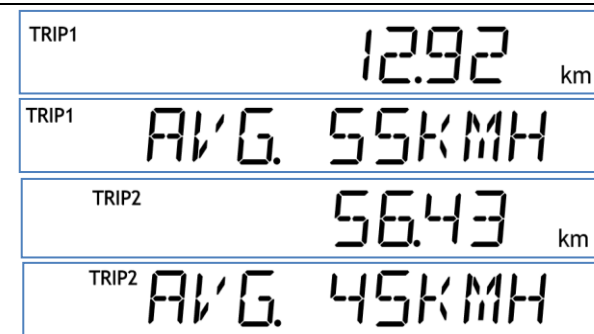

“TRIP2”

Exactly the same as TRIP1. Press **INFO** once to show ODO again.

Other messages

The bottom of the display shows other messages, such as warnings (scooter charging, side stand out, etc.), or operating errors (which start with “0x...”). If the latter appear, please contact your SILENCE Official Service Centre



Buttons

The buttons on the dashboard are **SET** (left) and **INFO** (right, and the same on the controls on the right side of the handlebar):



Their functions are as follows:

Browsing panels

Press **INFO** (press once): this will take you through the following screens with each press, in this order: **ODO -> TEMP -> TRIP1 -> TRIP2 -> ODO -> ...**

Change view: partial km/partial miles – average speed (AVG)

In TRIP1 or TRIP2, press **INFO (hold down)**.

Reset partial km/miles

In TRIP1 or TRIP2, press **SET (press once)**. The kilometres will be set to zero.

Change to Temperatures view

In TEMP, press **INFO (hold down)**: navigate the screens **TEMP BAT -> TEMP ENG -> TEMP INV -> TEMP BAT -> ...**

Change Time

Press SET (and hold): you will enter the time change mode.

Press SET (press once): you will switch between hours, minutes and time mode (they will start flashing).

With the hours flashing, **press INFO (press once)**: it will increase by one unit per press. **Press INFO (and hold)**: the hour will increase quickly.

With the minutes flashing, **press INFO (press once)**: it will increase by one unit per press. **Press INFO (and hold)**: the minutes will increase quickly.

With the time mode flashing, **press INFO (press once)**: this will allow you to switch between AM/PM and 24-hour mode.

Press SET (hold down): set the time and exit the time change mode.

Change Unit System











Press SET (hold down before and during the start of the scooter): this will switch you from the metric system (°C, km/h, km) to imperial measurements (°F, mph, mi), and vice versa.

Change screen brightness

In ODO, **press SET (press once)**: you can adjust the backlight brightness of the screen with 5 levels.

Warning lights



	Left indicator light.
	High beam light.
	Low beam light.
	OBD light. It comes on when there is an issue. If the issue disappears, the light should go off after you restart the scooter 3 times.
	Reverse gear light.
	Gear light. It comes on when the scooter has done all the necessary checks and it is ready to drive.
	Side stand (or kickstand) light. It comes on when the stand is out. Driving is not permitted with the stand out (automatic safety shutdown).
	Temperature indicator. It flashes when a component is approaching its permissible (upper or lower) limit. It stays on when it exceeds it. Motor: 100 °C (flash), 110 °C (on). Inverter: 70 °C (flash), 75 °C (on). Battery: 50 °C (flash), 60 °C (on)/5 °C (flash), -10 °C (on)
	Charge light. It remains on when connected to the mains.
	Right indicator light.

4) Vehicle control and driving elements

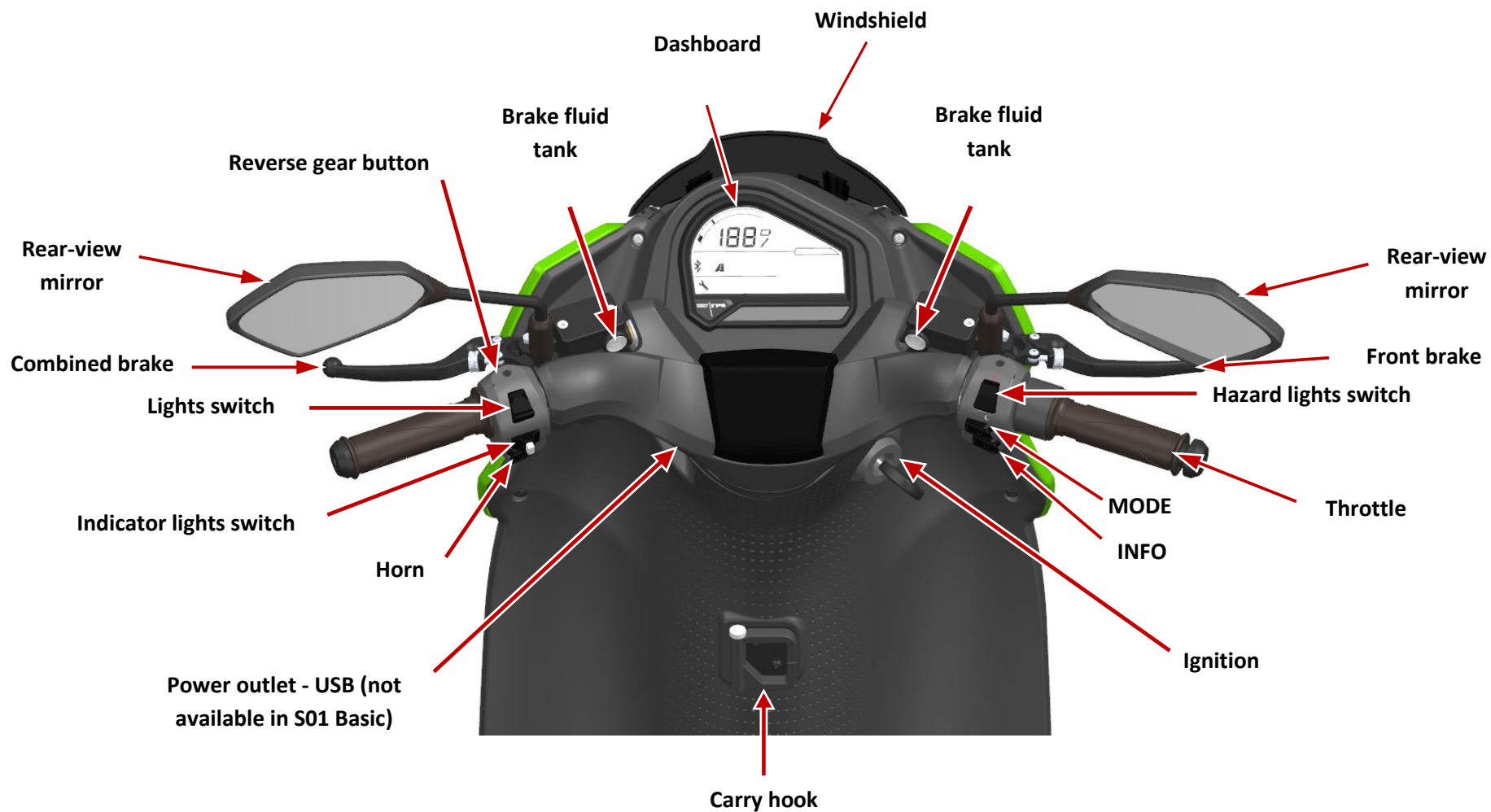

Combined brake and regenerative brake

This scooter is equipped with a combined braking system that works as follows:

The **right brake** mechanically brakes the front wheel (with the disc brake), while the **left brake** mechanically brakes the front and rear wheels (by applying force to both discs, thanks to a braking distribution system). Both sides electronically activate the regenerative brake of the rear wheel. Both levers are adjustable (see “**Adjusting the brake lever**” section).

With regards to the **regenerative brake**, it can be activated by lightly pressing each lever, using it without needing to apply the mechanical brake. Then both brakes are activated together. Using the regenerative brake helps braking while maintaining battery charge.

The regenerative brake applied depends on the driving mode selected, (see “**DRIVING MODES**”):

- The regenerative brake is activated when either of the two levers is pressed.
This system brakes the rear wheel electronically and regenerates energy in the battery:

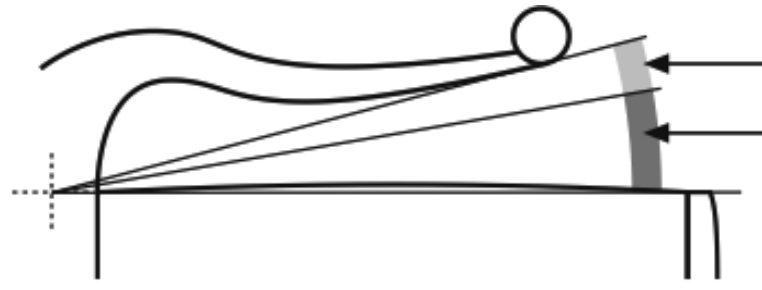

- If you continue to press the brake lever, the mechanical brake on the front wheel will also be engaged (or both, if you press the left lever); the greater the pressure applied, the greater the mechanical braking power.
- The regenerative brake is also applied, **to a lesser extent, when you stop accelerating** (depending on the selected mode).

Controls on the left side of the handlebar

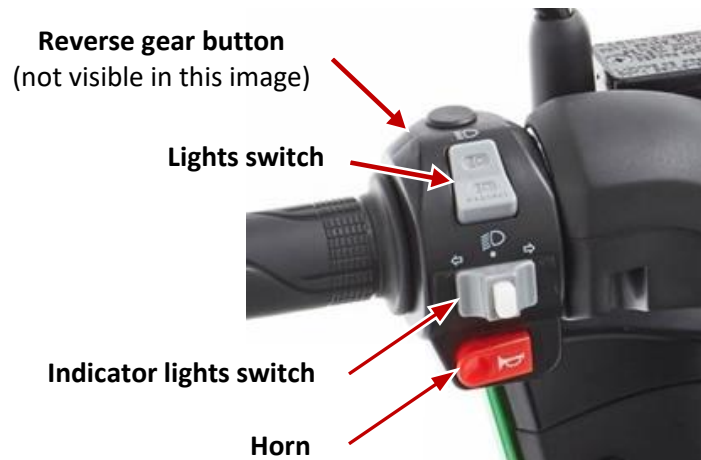

Lights switch:

- **Position 1** (push-button -> after being pressed down, it returns to the central position): **FLASHING**. It allows you to flash the high beams when it is pressed, as a warning to other drivers on the road.
- **Position 2** (switch -> remains in position 2, top): **HIGH BEAMS** come on.



Posición 1



Posición 2

In any case, when the high beams are on, the following blue light will come on in the dashboard:



Indicator lights switch:

To activate the indicator signal, move the switch to the right to indicate a turn to the right and move the switch to the left to indicate a turn to the left. The scooter will beep with each flash of the indicator light. Press the central **white** button to reset the switch position and turn the indicator lights off.

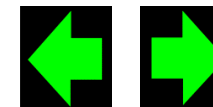

Horn:

Press the button **with the horn symbol** to honk the horn:



Reverse gear switch:

This scooter has a reverse gear. To use this function, press the **green** button behind the left brake lever and, **while pressing it**, accelerate smoothly. The following warning light will come on in the dashboard and make an intermittent beeping sound:



Use it carefully, especially the first time. This helps you to manoeuvre for parking or to get out of a parking spot in reverse gear.

Controls on the right side of the handlebar



Throttle:

To accelerate, turn the throttle towards you and down. Move the throttle back to return to the neutral position.

Hazard lights switch:

- **Position 1** (push button -> returns to the neutral position): switches between **DAYTIME LIGHTS** and **LOW BEAMS**. As long as the latter are on, the green light with the following shape on the dashboard will also be on.
- **Position 2** (push-button -> returns to the neutral position): **HAZARD LIGHTS**. Switches the indicator lights on and off on both sides at the same time. A beeping sound will be made with each flash of the indicator light. You can switch on your *hazard lights* and leave them on with the key out of the ignition. To do so, switch them on with the key in and then remove it. After they have been switched off, they can't be switched on again without putting the key back in.



“INFO” button:

This button is the same as the INFO button on the speedometer and has the same functions (see the “**Dashboard**” section).

“MODE” button:

This button has three functions:

- **Starting the scooter:** unlock the steering lock first (if locked). After you start the vehicle with the key (or also with the *app*, in the **LS**, **Connected** and **Plus** versions) and wait for the information displayed on the LCD screen to stabilise, press the **MODE** button and at the same time **the left brake lever**, until the green “**D**” lights up on the dashboard and you hear a chime. Now, the vehicle is ready to be driven. The daytime lights will also switch on (the sidelights go on automatically when you turn the key to ON). 
- **Mode selector:** this scooter has different driving maps, which can be selected with the **MODE** button (see **DRIVING MODES** section).
- **Switching off the scooter:** (new for MY23) it is possible to switch off the vehicle without the key and without having to access the *app* again, simply by folding out the side stand and pressing the **MODE** button for at least 3 seconds.

5) Ignition

Switch positions:

Handlebar lock



Turn the handlebar all the way to the left. Put the key in, push it in and turn to the left, to the "lock" position.

Now all the functions are blocked and the scooter movements are highly limited.

"OFF": Shutdown/unlocking the handlebar



All the functions are locked but the handlebar is not (the scooter can be moved). You can work on the scooter safely (removing the keys is still always recommended).

As well as with the key, the vehicle can be switched off by folding out the side stand and pressing the MODE button for +3 seconds.

"ON"



All functions are ready to be used. The scooter is ready to be driven if you hold the MODE button and the left brake lever pressed until "READY" appears on the speedometer and the green drive light (D) comes on. In this position, the key cannot be removed.

In addition to the key, the **LS**, **Connected** and **Plus** versions can be switched on via the "My Silence" app, which allows the scooter to be shared without the need for a physical key (although the handlebar must not be blocked).

Seat opening



Insert the key and, without pressing inward, turn it to the left until a click is heard from the seat (when the seat latch opens). In the **Plus** version, you can also open it through the *app* or with the brake levers (see **Opening and closing the seat** section).



6) Lighting

All the lights on this scooter use **LED technology**, including indicator lights, sidelights, daytime lights, brake lights, high beams and low beams. Refer to the “**Vehicle control and driving elements**” section. There are no light bulbs to change.

The various lighting groups are:

Headlight

Includes high beams (top), low beams (bottom) and side lights (perimeter semi-circles).

Daytime and front indicator lights

On each side of the headlight is an LED assembly that combines the functions of the daytime running light and the indicator lights.

Taillight

A LED module is situated on the rear of the scooter, which groups the rear side, braking and indicator lights.

License plate light

Under the rear reflector is the LED module that illuminates the license plate.

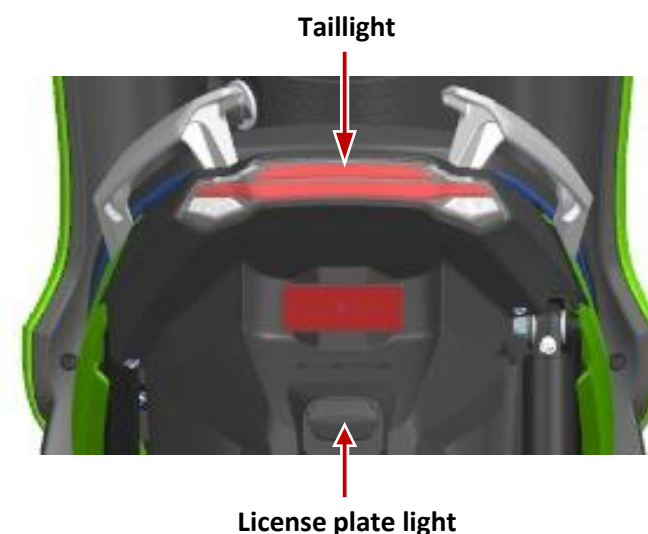
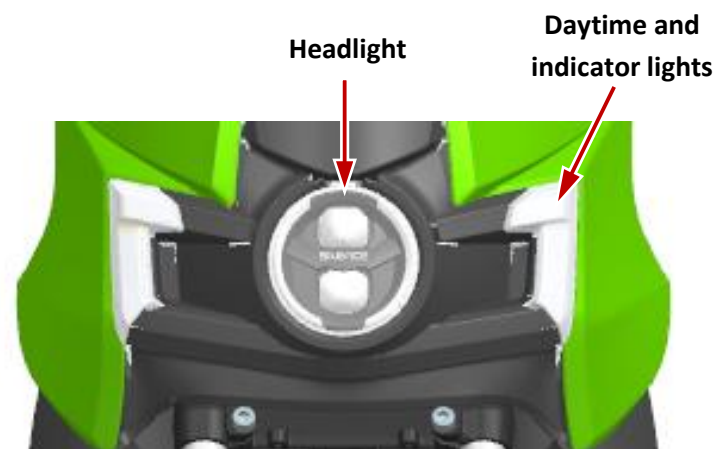

Headlight adjustment

To adjust the headlight, turn the screw **1** behind it, using an 8 mm ratchet wrench or a Phillips head screwdriver.



The screw is accessed from the opening **2** between the headlight and the front fender. The adjustment screw is in a place that is not easy to access; if you cannot manage to adjust it yourself, please take the scooter to your nearest SILENCE Official Service Centre.



ADJUSTING THE LIGHT BEAM POSITION UP

To adjust the light beam position **upwards** (high and low beams), turn the screw **clockwise** (if you are looking at the scooter's headlight).

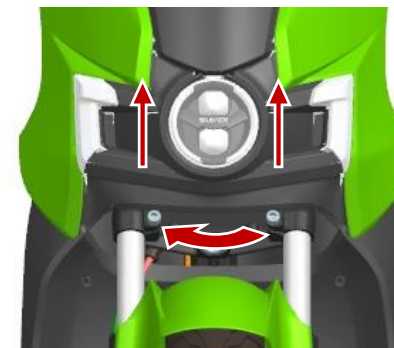

ADJUSTING THE LIGHT BEAM POSITION DOWN

To adjust the light beam position **downwards** (high and low beams), turn the screw **counter-clockwise** (if you are looking at the scooter's headlight).

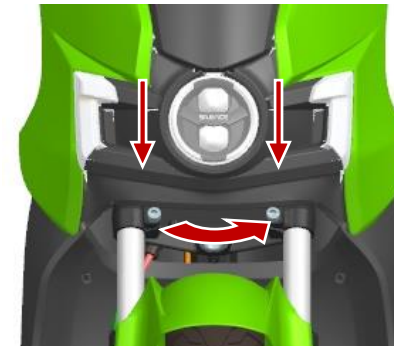

7) Seat - Compartment under the seat

Opening and closing the seat

The seat of your SILENCE S01 can accommodate the driver plus one passenger, and includes a large compartment underneath it, with a capacity to store 2 helmets. The seat is **opened 1)** with the scooter’s key (see “**Seat opening**” section). In the **S01+**, it can also be done by **2)** braking with both levers, with the scooter turned on and the side stand deployed or **3)** via the “**My Silence**” app. To **close it**, lower it and press on the seat until it is locked. **Make sure it is locked before you start driving.**



In the compartment under the seat, you will find the following elements (explained below):

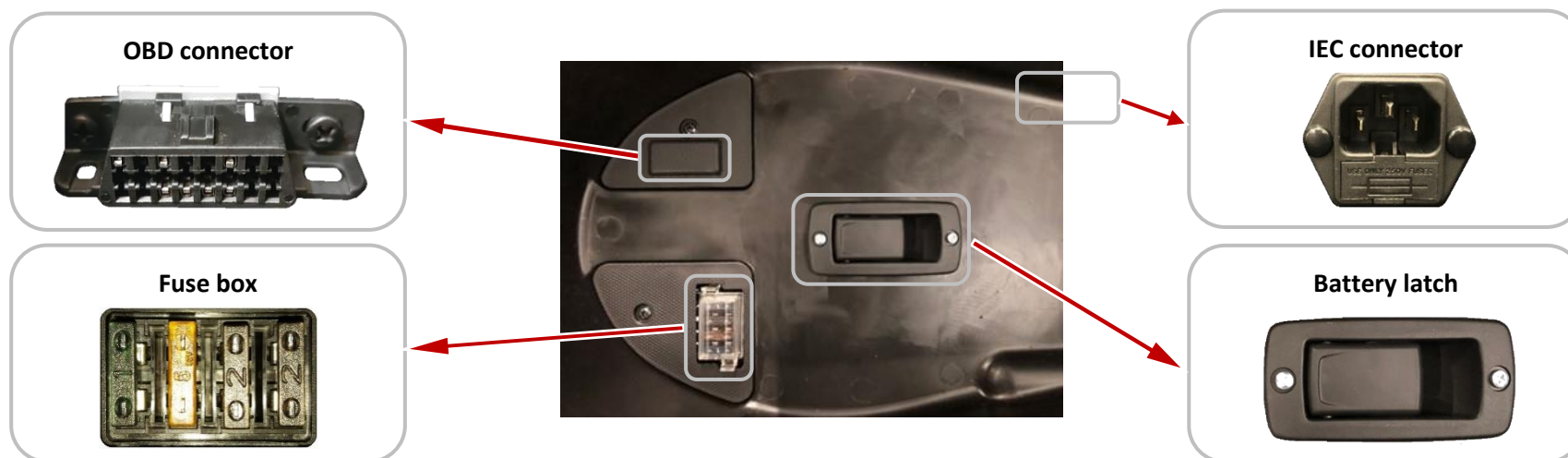

Removing the battery

ATTENTION: Before proceeding to remove the battery, you must take into account the risks associated with this operation:

ELECTRIC RISK:

- **NEVER** remove or insert the battery pack when the scooter is **charging** or with the **key in the ignition**.

RISK OF DAMAGE TO THE TELESCOPIC SYSTEM:

- Make sure **NOT to unfold the handle before pulling the pack out** (unfold it after the battery has been removed from the scooter), **nor insert it with the handle unfolded** (fold it before inserting).

RISK OF THE BATTERY FALLING ON YOUR FEET:

- The wheels and base of the pack slide out and fold up automatically when you remove it or insert it into the scooter. **Nevertheless, it is your responsibility to do this slowly and to make sure the wheels and base come out properly, and ensure that when inserting it, it is properly anchored** (check before driving). Otherwise, there is a risk of falling on your feet, resulting in **personal injury**.



RISK OF ENTRAPMENT OF HANDS:

- **DO NOT** try to deploy the landing gear by hand or reach under the battery under any circumstances.

EXTRACTION PROCESS:

To remove the battery pack easily in just a few seconds, follow these steps **(with the scooter on the centre stand)**:



Open the seat



Press the latch Remove the battery pack



Unfold the handle



Transport the battery pack



Connect it to any socket



Once charged, unplug it



Transport and insert the battery pack into the scooter



Make sure that the battery is properly secured

ATTENTION: BATTERY NOT CONNECTED

When the battery does not make proper contact with the scooter, the information "**BATT OUT**" appears on the dashboard (once properly connected, the usual information will be displayed):

BATT OUT

BP KEY LOCK

Furthermore, your scooter features a **latch** to prevent the battery from being removed, which features a cylinder that locks the battery into place and is installed in front of the rear wheel, to the left, and is protected with a rubber cover:

- To activate it (and lock the battery), simply press it inwards (towards the battery).
- Insert the key in the latch and turn to release it.



ATTENTION: Check that the rubber cover is always in place when driving, thus protecting the cylinder and preventing dirt from entering. **Otherwise, it could become unusable.**

RUBBER CAP

Whenever the battery is not in the scooter, the part of the power multipin connector that is on the scooter must be covered with the rubber cap designed for this purpose. The goal is to protect it while it is disconnected:

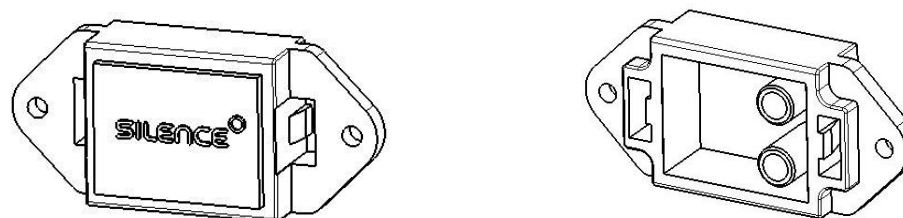

ATTENTION: do not put the protective cap on while the scooter is plugged in and never get the connector wet (even with the cap on).

Fuse box

The fuse box is located under a protective lid, inside the seat compartment:

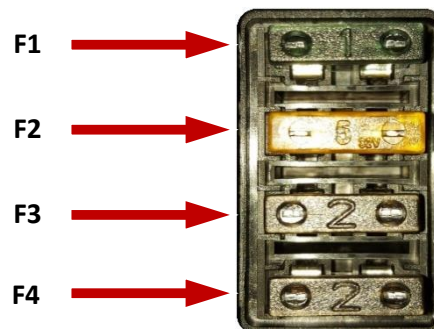

The scooter has **4 fuses**, from top to bottom in the image (or from left to right on the scooter):

- **F1 (Black)**: 1A fuse to protect the USB port.
- **F2 (Orange)**: 5A fuse protecting the power source for lights, horn, etc. (DC/DC 12V output).
- **F3 (Grey)**: 2A fuse protecting the DC/DC converter (DC/DC 60V input).
- **F4 (Grey)**: 2A fuse protecting the Inverter (MCU).

8) Suspensions

Front fork

The front suspension of the S01 consists of a conventional hydraulic telescopic fork for all variants **1**.

In the case of the fork on the **Plus** variant, it is possible to adjust* the spring **preload** **2**.

In the rest of the variants, the front fork is not adjustable.

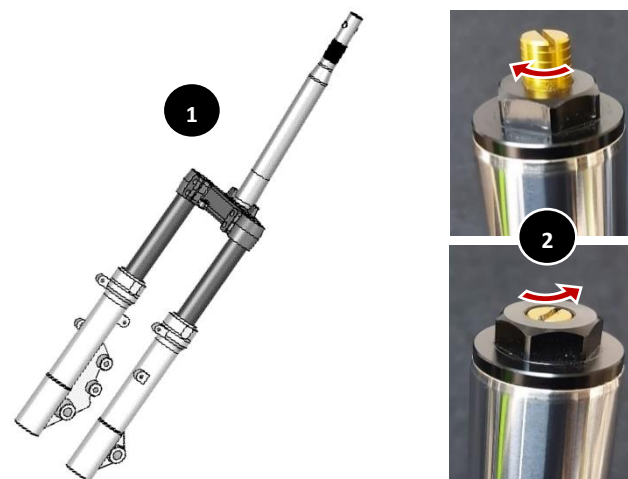

Rear monoshock absorber

The rear suspension consists of a lateral hydraulic monoshock absorber.

- In the case **3** of the **LS, Basic, Standard** and **Connected** variants, the **preload** can be set* in **3 different positions**. In addition, it has an air load that must be maintained at **6 bar** pressure (**do not touch**).
- In the case **4** of the **Plus** variant, the **preload** can be adjusted* in a **wide range** of positions. In addition, the **compression** can be modified in **15 different positions**. This value can be changed by the user, by means of a knob provided for this purpose: turn **clockwise to harden** (H) and **counterclockwise to soften** (S).

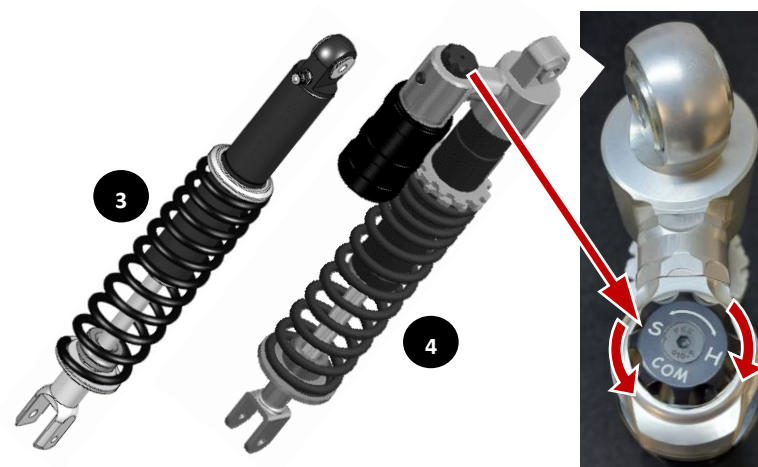

*In any case, the regulation of the preload, carried out by any of these systems, must be done at a SILENCE Official Service Centre.

9) Stands

Side stand

The side stand is on the left side of the scooter.

To put the side stand down, push the “V”-shaped leg down **5** that sticks out from the side stand. The side stand should be used when the ground is too unstable or on a slight incline, making it impossible to use the centre stand.



Centre stand

The centre stand is located under the scooter in the centre.

This stand keeps the scooter in a vertical position.

To lower the stand, push the leg down with your foot as you push or pull the scooter gently up and rearwards (we recommend holding the handlebar and rear grab bar while doing this).

The centre stand should be used when the ground is stable or flat, and for long parking periods or servicing.



10) Rear-view mirrors

Before driving, always make sure both mirrors are properly adjusted to the current driver of the scooter.



11) Accessories

There is a wide range of accessories available to customise your S01, according to your needs: high windshield, load carrying accessories such as top cases, smartphone holder, etc. **Check the official website for more information.**

DRIVING MODES

This scooter has different **driving modes**, available depending on the variant (**LS, Basic, Connected, Standard or Plus**). They are:



Each mode has features (acceleration, maximum speed, regenerative braking) that make it ideal for one type of driving or another. **You decide which one is best for you at all times!**

Remember that your scooter also has a **reverse gear** which, unlike the rest of the other modes, is activated by means of a **specific button** (see “Reverse gear switch:” section).

SELECTION

To select one of the 3 main modes (**ECO, CITY or SPORT**), you can do so by using the “**MODE**” button:. The current mode will be indicated on the dashboard display. A single press of the button will switch between these modes, following the sequence¹:

C-S-C-E-C-S-C-...

During the transition between one mode and another, the name of the next mode will flash on the screen for a few seconds and will be activated and remain on the screen. This allows us to skip 2 modes without having to activate the mode that comes next in the sequence.

You can go directly from SPORT to CITY, but to switch to ECO from any mode you must be driving at a speed of less than 55 km/h.

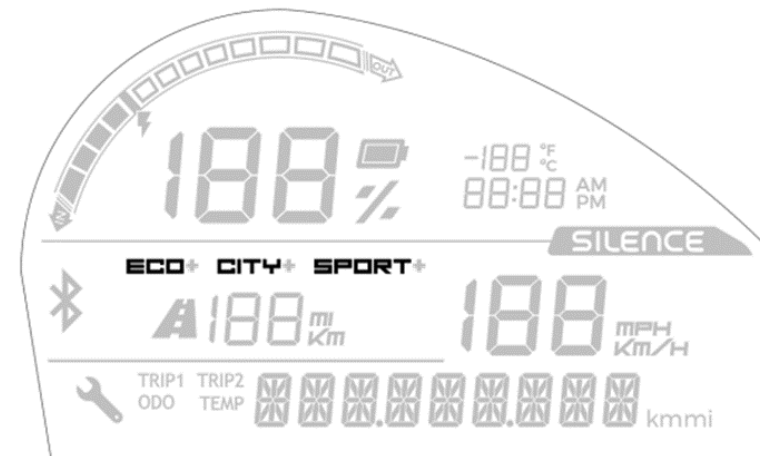

¹ In the S01 Basic variant, as it only has ECO and CITY modes, the sequence is simply: C-E-C-E-C-...

CITY

Default mode when the scooter is turned on, which offers a good performance for the vehicle. It does not use regenerative braking.

ECO

This mode is programmed for **more relaxed driving**, with limited speed and acceleration. It gives the vehicle a **longer range**. **It uses regenerative braking**.

SPORT

This mode allows for **greater power and speed** in specific situations. Frequent use of the SPORT mode decreases the range of the scooter (range of total km on one charge), due to higher energy consumption and may cause the motor/battery temperature to rise excessively, resulting in decreased performance or disconnection of the scooter. **It uses regenerative braking**.

All SPORT mode features will be available as long as the following conditions are met (all of them):

SoC > 20 %

T_{bat} < 45 °C

T_{mot} < 105 °C

T_{inv} < 70 °C

...where **SoC** refers to the battery charge level and the **Ts** to the battery, motor or inverter temperatures, respectively.

In summary:

MODES	Regen. ² [%]	VARIANTS				Max. Sp [km/h]
		S01 LS	S01 BASIC	S01 CON. / STD.	S01 +	
ECO	✓	25	70	70	70	
CITY	✗	45	80	80	80	
SPORT	✓	45	✗	95	110	

For safety reasons, the power will be cut off in any of the following cases, as a self-protection measure:

T_{bat} ≥ 60 °C	T_{mot} ≥ 110 °C	T_{inv} ≥ 75 °C
--------------------------------	---------------------------------	--------------------------------

To prevent this scenario from happening, a gradual reduction in power may occur as you approach these values.

WARNING

This scooter is **NOT** made to go on the highway/motorway **continuously**, although it could drive on these roads every now and again, if the country's legislation allows it. The vehicle is designed to be driven in CITY and ECO mode, without causing any critical element to overheat. If the vehicle is continuously used in SPORT mode (**LS, Connected, Standard and Plus** variants), the *battery pack* (BP) could overheat; for this reason, SILENCE has developed a system that optimises the vehicle's consumption and power to modify its performance while in use and avoid this type of problem.

² Regenerative braking **activates completely by applying pressure** to the brake levers. It does so with **less intensity by** simply releasing the throttle. Refer to the **“Combined brake and regenerative brake”** section.

“My Silence” app (only for connected versions)

If there is one thing that characterises the **S01 LS**, **S01 Connected** and **S01+**, it is the possibility of linking it to your smartphone through the “**My Silence**” mobile application. The app allows you to be connected to your scooter from anywhere, being able to share it with whoever you want in complete safety.

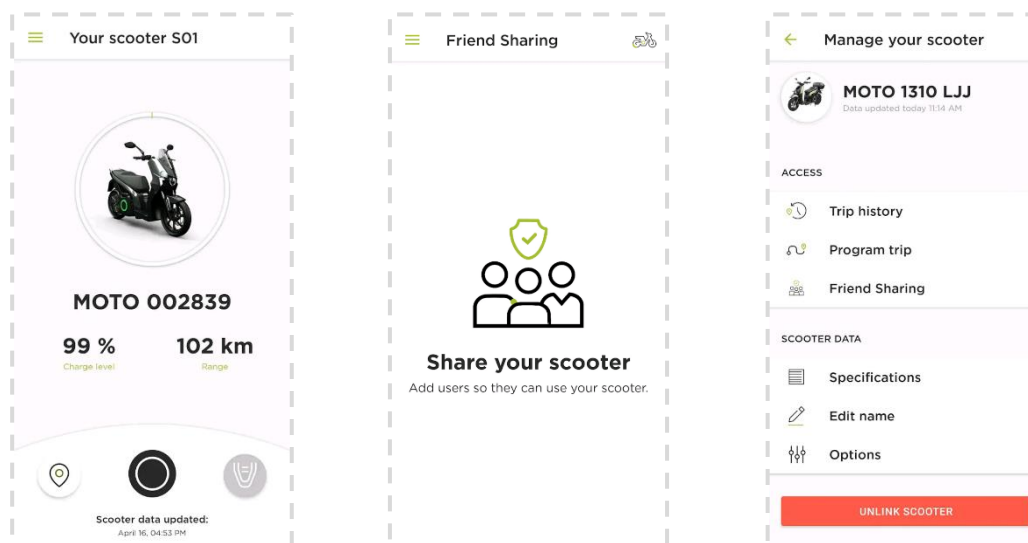

It is the first electric scooter that comes connected as standard from the time it is developed until it reaches the end user. Everything is designed by and for the client, making use of the scooter easier and always providing all the necessary information in a completely personalised way.



To pair it with your device, you simply need to know your VIN (see “**VIN number - Chassis number**” section) and download the *app* (available in **Google Play** and the **App Store**), open it and follow the instructions that appear in it. This mobile application is self-explanatory, so it will guide you through the entire process.

TECHNICAL SPECIFICATIONS

1) Scooter specifications (structure + motor)

STRUCTURE					
CHASSIS					
Construction	Steel tubes				
MAIN DIMENSIONS					
Total length	2026	mm	Wheelbase	1427	mm
Total width	722	mm	Seat height	790	mm
Total height	1193	mm			
MASSES					
MAM: Maximum Authorised Mass	320	kg	Weight of vehicle without battery	111	kg
MAM front axle	102	kg	Weight of the vehicle with a battery (4.1 / 5.6 kWh)	147 / 152	kg
MAM rear axle	218	kg	Weight of the battery (4.1 / 5.6 kWh)	36 / 41	kg
FRONT WHEEL ASSEMBLY			REAR WHEEL ASSEMBLY		
FRONT WHEEL			REAR WHEEL		
Front rim	15"		Rear rim	14"	
Front tyre	120/70-15		Rear tyre	140/70-14	
Front tyre pressure (alone/with passenger)	1.8 / 2.2	bar	Rear tyre pressure (alone/with passenger)	2.0 / 2.3	bar
FRONT BRAKE			REAR BRAKE		
Type	Disc (hydraulic, combined)		Type	Disc (hydraulic, combined) + Regenerative	
Diameter	260	mm	Diameter	240	mm
FRONT SUSPENSION			REAR SUSPENSION		
Type	Conventional hydraulic telescopic fork (see Front fork)		Type	Hydraulic monoshock (see Rear monoshock absorber)	
Length	90	mm	Length	100	mm

POWER TRAIN								
MOTOR								
Type	Brushless, on the wheel. Reversible: regenerative motor brake. Reverse gear							
Nominal power ³ (LS / Basic-Con.-Std. / Plus)	4 / 7 / 7.5	kW	Maximum vehicle speed (LS / Bas. / Con.-Std. / Plus)	45 / 80 / 95 / 110	km/h			
Peak power (LS / Basic-Con.-Std.-Plus)	7,3 / 11.8	kW	Power/mass ratio (LS / Basic-Con.-Std. / Plus)	0,036 / 0.063 / 0.068	kW/kg			
ENERGY EFFICIENCY								
S01 LS (BP 5.6 kWh)			S01 Basic (BP 4.1 kWh)			S01 Connected – Standard – Plus (BP 5.6 kWh)		
Energy consumption	58	Wh/km	Energy consumption	65	Wh/km	Energy consumption	70	Wh/km
Environmental regulations	Euro 5	-	Environmental regulations	Euro 5	-	Environmental regulations	Euro 5	-
Range	146	km	Range	100	km	Range	133	km

³ Homologated nominal and peak power. In the case of the **Basic** variant, the power is **electronically limited to 5 kW**.

2) Battery and charger specifications

WARNING

The battery can be a **VERY DANGEROUS** (life-threatening) product when it is not in the scooter:

- It should always be transported on its wheels, slowly (max. 3 km/h), slower than the average person walks.
- Be very careful with the battery, avoid hitting or bouncing it, rolling it over cobblestones, stairs or potholes, or dropping it (down stairs, for example), as this could cause it to catch fire. Avoid all contact with water.
- If there is any indication or you suspect the *battery pack* has been used improperly or has fallen, do not plug it in. Call a SILENCE Official Service Centre, as this could be **LIFE THREATENING**.

A battery fire can be put out with water, a CO₂ fire extinguisher or class D fire extinguisher, unless the battery is plugged in or near other batteries. In this case, use a CO₂ fire extinguisher or class D fire extinguisher to put out the fire and take it to a safer, more isolated location (at least 15 m from any exposure: other vehicles, batteries, etc.). Once in a secure location, call emergency services to take control of the situation.

BATTERY SPECIFICATIONS

	4.1 kWh (S01 Basic)	5.6 kWh (S01 LS - Con. - Std - Plus)
Nominal capacity	4.1 kWh (S01 Basic)	5.6 kWh (S01 LS - Con. - Std - Plus)
Cell chemicals	Lithium-ion cells	
Weight	36 kg	41 kg
Unfolded height	870 mm	
Box height	270 mm	
Wheel width	330 mm	
Box depth	440 mm	
Nominal voltage of the battery	51 VDC	
Storage temperature (not charging)	-20 a 45 °C (max.) / 0 a 25 °C (recommended)	
Operating temperature	0 a 50 °C (charging) / -10 a 60 °C (use, discharging)	
Housing material	Aluminium and PC	
Max. charging current	30 A	35 A
Max. discharge current	160 A	280 A
Type of charger	Onboard 90-240 VAC; 600 W	
Max. internal charger current	~11 A	
Standard charge time	5-7 h	7-9 h

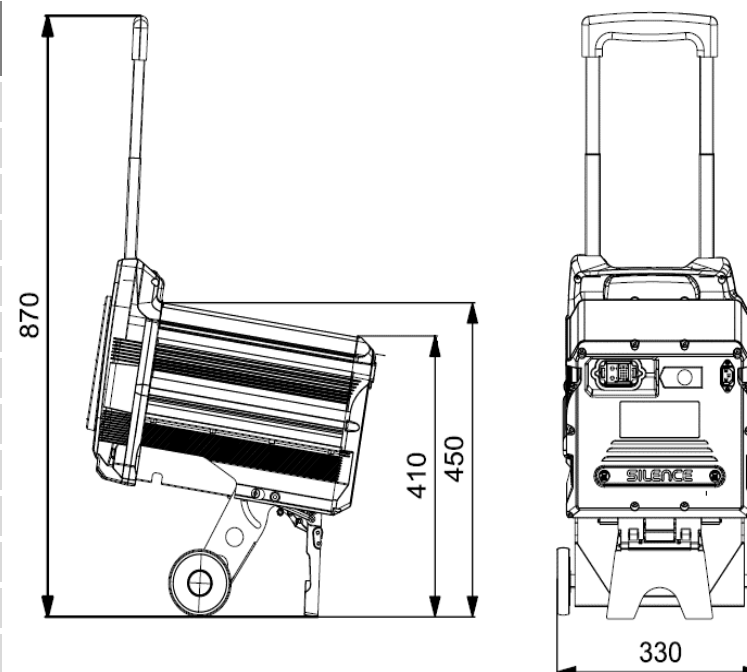

BATTERY PACK

1) Components

The SILENCE S01 model has an innovative removable battery pack which, in addition to its basic internal systems, also has the following elements:

Trolley-type removal system

This system includes an extendable handle, two wheels and a support base (to use on flat, horizontal surfaces). To learn more about how to remove it from the scooter, see the **“Removing the battery”** section.



Internal charger











Integrated into one of the side covers, the internal 600 W charger allows the battery to be charged in the scooter or when removed, using any conventional plug (Schuko) with a Schuko to IEC power cable (supplied with the scooter):



Light ring

Information on the battery charge level is available, whether or not the battery is in the scooter, on an LED light ring on one side of the battery pack (if the scooter ignition is on, the ring will not light up under any circumstances):



	BP's WITH GREEN COLOUR CODING	BP's WITH REDDISH COLOUR CODING
BP NOT CHARGING	By touching the inside of the ring lightly, it will display the following:	
	RED and BLUE light trails, each moving around the ring in opposite directions. Following this, it will be shown in TURQUOISE. 	One REDDISH and one WHITE light trail. 
	Then the percentage of remaining charge will be indicated momentarily, by means of:	
	A portion of the ring lit up in GREEN (or the entire ring, if the charge is at 100 %). 	A portion of the ring lit up in a REDDISH colour (or the entire ring, if the charge is at 100 %). 
In the case of low battery charge:		
The entire ring will be displayed in RED. 	The entire ring will be displayed in YELLOW. 	
BP CHARGING	While the battery is charging, it will alternate between:	
	A GREEN light trail that moves around the ring and a portion of the ring that's lit up, showing the percentage of the battery that is charged. 	A REDDISH light trail that moves around the ring with a portion of the ring that's lit up, showing the percentage of the battery that is charged. 
	Once it reaches 100 %, the ring will display:	
It will be all GREEN with a BLUE light trail moving around the ring while it is still plugged in. 	It will be all REDDISH with a WHITE light trail moving around the ring while it is still plugged in. 	

2) Energy

Along with our removable battery system, we have created a series of parts to give our batteries additional uses. The idea is to not only get around the city on your electric scooter and be able to charge it wherever you want and whenever you want, but now you can also use it to power many other devices.



- **Energy IN:** On the one hand, you will find the power to charge the battery pack, which at SILENCE we call “Energy IN”. You can charge your battery directly from the mains with a normal socket, or find a charged pack at one of our **Battery Swapping Stations (BSS)**.
 - ➔ **WARNING:** only use the quick charging devices supplied by SILENCE to ensure the validity of the warranty.
- **Energy OUT:** On the other hand, “Energy OUT” is for everything that can be powered using the battery, i.e. all the applications of the battery pack: power for your S01 or other models, or for your computer, television, camping stove, coffee maker or microwave, for example.
 - ➔ **WARNING:** only use the quick charging devices supplied by SILENCE to ensure the validity of the warranty.. See next page.

Everything that requires electricity to run can be powered ⁴ thanks to the inverter that SILENCE has developed for you. Thanks to its backpack design, the **NOMAD** is portable (as is your removable battery), allowing you to use both wherever you are.

All you have to do is connect the BP to the **NOMAD**, along with the device you want to use. You can connect different household appliances or electrical devices, be it a mobile phone, a laptop, a coffee maker, a lamp, a TV, a fan, a portable refrigerator, a toaster... up to a maximum output of **3000 W**, thanks to its **two 220 V alternating current outlets** (2 Schuko connectors) plus its **USB output of 5 V of direct current**.



3) Exchanging batteries

If you have purchased your S01 with battery rental, you will be able to use the **Battery Swapping Stations (BSS)** to exchange batteries. You will be able to reserve a charged and available battery through the **“Battery Station”** app, and exchange it for your battery with a low charge, wasting no time on charging batteries.



⁴ According to the technical specifications of the device.

4) Battery Management System (BMS)

This battery has a **BMS (Battery Management System)**, which controls parameters such as temperature and voltage. It was developed by the SILENCE R&D team and plays a very important role in balancing the charge between the different cells, making sure the battery works at an optimal level.

This system also provides information on the charge level and sets protocols for charge and discharge currents. It also includes an action plan in case of an irregular battery status, triggering preventive measures in case of power, voltage or temperature spikes or losses, etc.

In short, the BMS is the battery's "brain", ensuring optimal performance and safety.

5) Connecting the charging unit

You can charge your S01 battery on the scooter or separately. Both the scooter and the battery have an **IEC male contact ①** for the **power cable**. The cable has a **female IEC terminal contact ②** and a **male Schuko terminal ③** (commonly used in Europe to connect to the domestic network), and is normally stored in the compartment under the seat, where the male connector is located ① (see **Seat - Compartment under the seat** section). On the battery, it is located on the back ④:

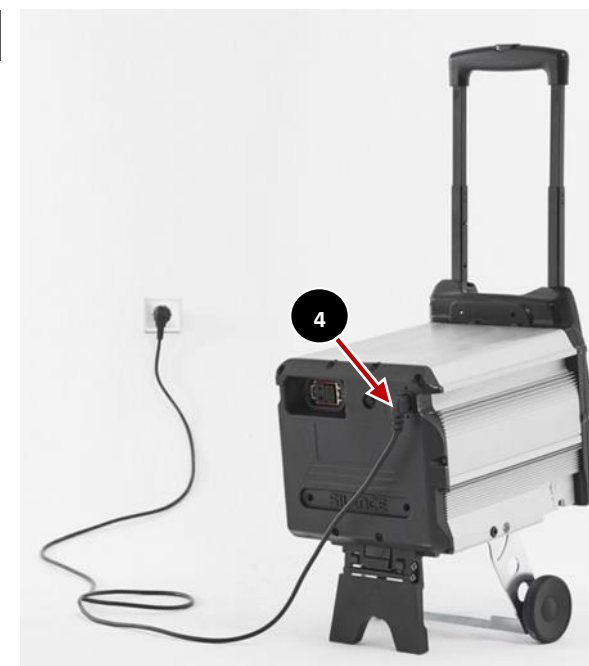

Before removing or putting the battery pack on the scooter, make sure it is not charging and that the key is not in the ignition.

The charger (600 W) is part of the battery pack, so all you need to charge the battery is a mains power point and the power cable. It uses convection cooling.

- **To connect**, first plug in the IEC connector (scooter or battery) and then plug it into the mains. It is necessary to fully charge the battery after it has been partially charged 3 or 4 times. Similarly, it is also necessary to perform a full slow charge after 3 or 4 fast charges.

- **To disconnect**, first unplug it from the mains and then unplug the IEC connector. The charging process can be stopped at any time. Also, the control system will stop charging the battery when it reaches 100 %.

If the battery temperature is below **0 °C** or over **50 °C** (due to improper use), it will not charge.

IMPORTANT!

Charge the battery fully once every 30 days to ensure the validity of the warranty*.

If it is **connected** while at a low temperature, an internal heater will be switched on until the battery reaches a temperature that is appropriate for the charge (**in the case of battery units with this element activated**). This heater works when plugged into the mains and allows the power to be transferred at the right temperature. However, this has an impact on the charge time, which will take longer than if the temperature conditions were within the normal range.

For cold regions and seasons, we recommend keeping the battery plugged into the mains so the heater can warm the cells and keep them at the right temperature for the scooter to be used normally.

***To ensure the validity of your battery's warranty, you must charge it fully (to 100 %) at least once a month.** If you know you will not be using it for a while, it is important to leave the battery with enough charge level so that it does not reach critical levels. Batteries that fall below a certain level of voltage no longer work on their own, meaning they cannot be charged and must be taken to an Official Service Centre.

6) Temperature

This scooter has a system that controls and stabilises the voltage and temperature of the cells. To avoid critical situations, the safety systems limit battery use if the cell temperature exceeds safe levels due to overheating or overcooling.

- The battery's operating range is between -10 °C and 60 °C. The performance of the lithium cells may vary depending on the temperature.
- The charger will not charge the battery if the cell temperature is below 0°C or above 50°C.
- The current battery temperature is shown on the scooter display. If any of the limits are surpassed (upper or lower, warning or failure), the following LED will come on:



Temperature indicator. It flashes when a component is approaching its permissible (upper or lower) limit. It stays on when it exceeds the limit.

Motor: 100 °C (flash), 110 °C (on). **Inverter:** 70 °C (flash), 75 °C (on). **Battery:** 50 °C (flash), 60 °C (on) / 5 °C (flash), -10 °C (on).

Depending on the situation, the following actions should be taken:

- **Low temperature:** The battery will not function in optimum conditions; store it in a warmer place and charge it (if you have an internal heater on).
- **High temperature:** The battery cannot deliver more power, due to intensive use; avoid using the SPORT mode and stop the vehicle if needed to cool the battery down.

7) Battery charge level, in % (SoC)

To get as precise a reading as possible for the **state of charge (SoC, in %)**, make sure that the battery is charged up to 100 % of its capacity (at least after 3 or 4 partial charging processes).

8) Range

The range of an electric vehicle is the distance it can travel on a single full charge of the battery.

This is influenced by many factors, including driving style, scooter load (kg) and distribution, tyre pressure or adverse weather conditions, such as wind, which can reduce the range.

The display shows an estimated number of kilometres (or miles) left. This is **approximate** and depends on the driving mode (**CITY/ECO/SPORT**) and current use of power.

9) Best practices for battery charging

The battery should be charged following these recommendations:

- When charging at home, place the battery in isolated and ventilated areas such as garages, laundry rooms, storage rooms or patios.
- Do not charge the battery in the rain when it is outside the scooter.
- Do not charge in areas where people walk or at the entrance to the home.
- Keep the battery away from things that are hot or those that can give off heat, such as radiators or heaters.
- Keep the battery away from mobile elements, such as vehicles or doors, preventing anything from possibly hitting it.
- Keep the battery at a safe distance from other things such as tables, cabinets, chairs and shelves.
- Regularly monitor the battery while charging.

10) Best practices to ensure correct battery maintenance

The battery has a maximum service life of 1,000 cycles, maintaining 80 % of its capacity if it is serviced according to the warranty and a series of recommendations are followed:

- Avoid using the SPORT mode excessively, trying to use the CITY mode as long as possible (reason: avoid aggressive driving with continuous sudden accelerations).
- Make sure that the battery is not fully discharged; charge it when its charge level is at around 25 % of the SoC, thus avoiding complete charge cycles and limiting the depth of discharge.
- Keep the battery at a temperature of 20-30 °C and ensure that the battery operates outside this range for as little time as possible. The battery will deteriorate faster when it is operated outside this temperature range, losing its properties.
- If possible, use the internal charging system and try not to use quick chargers continuously. Perform a full slow charge after 3 or 4 quick charges.

11) Safety information regarding the battery

WARNING



NEVER OPEN THE BATTERY BOX

THIS CAN BE EXTREMELY DANGEROUS AND WILL TOTALLY VOID THE WARRANTY.

ONLY AUTHORISED PERSONNEL MAY WORK ON THE BATTERY BOX.

IN THE EVENT THAT SMOKE STARTS TO COME OUT OF THE BATTERY, YOU MUST URGENTLY CALL THE FIRE BRIGADE (DANGER OF DEATH) AND REMOVE IT FROM THE ENCLOSED SPACE IN WHICH IT IS LOCATED.

THE VEHICLE CANNOT EXPLODE, SO THERE IS NO PROBLEM IN TRANSPORTING IT TO A SAFE LOCATION.

WARNING



TO PREVENT INJURIES, BURNS OR ELECTRIC SHOCKS:

- NEVER DISASSEMBLE THE BATTERY PACK OR REMOVE ITS CAPS. ONLY AUTHORISED PERSONNEL ARE PERMITTED TO DO SO.
- KEEP CHILDREN AWAY FROM THIS PART OF THE SCOOTER.
- DO NOT PERFORATE OR BUMP THIS AREA WHEN USING HOISTS, DO NOT EXPOSE IT TO FLAMES, INCINERATE IT OR EXPOSE IT TO LIQUIDS, AS THE GENERATION OF EXCESS HEAT MAY LEAD TO FIRE, WHICH COULD BE VERY DANGEROUS.

QUALIFIED AUTHORISED STAFF

YOU MUST READ THE SERVICE MANUAL BEFORE REPAIRING OR REPLACING THE BATTERY.

First aid measures

In the case of a broken battery, smoke or fire, evacuate people from the contaminated area and provide as much ventilation as possible to clear out the gasses. Seek medical attention.

- **Contact with eyes:** flush with water (eyes open) for at least 10 minutes.
- **Contact with skin:** remove contaminated clothing and flush the affected area with soap and water for at least 15 minutes. Do not apply grease or ointments.
- **Inhalation:** take outdoors and ventilate the contaminated area. Provide oxygen or artificial respiration if necessary.

Fire protection measures

Extinguishing measures:

- **The following can be used:** D-type, CO₂ and dry chemical extinguishers. Water if the scooter/battery is not connected to the mains or near other batteries.
- **Specific hazards:** cells overheating due to external heat sources or improper use.

DISPOSAL AND RECYCLING

1) Recycling the battery pack

S01 battery packs that have reached the end of their service life must be disposed of in compliance with the applicable regulations and always respecting the environment. The Law prohibits disposing of battery packs in domestic waste containers. The pack must be deposited at an authorised SILENCE Service Centre to ensure it is recycled properly, reducing its environmental impact.



2) Recycling the scooter

When you need to dispose of your SILENCE scooter, you must do so according to the applicable regulations and always respecting the environment. For more information about recycling and disposal of your scooter, please contact an authorised SILENCE Service Centre, which will provide you with the guidelines for proper disposal of the scooter and all of its components at the end of its service life.



MAINTENANCE SCHEDULE

As with any other vehicle on the road, regular maintenance and inspection is required before each use. This is the only way to ensure your own safety and that of others on the road, while also guaranteeing an optimal experience on the scooter.

When carrying out maintenance work, always take your scooter to a SILENCE Official Service Centre, as they know your scooter best and have the right tools to diagnose and repair it. However, there are some things you can (and should) check yourself, such as tyre pressure, brake fluid level, etc.

DISCLAIMERS

- These instructions were drafted for owners that will only use the S01 in urban areas. If you use it for a purpose other than that for which it was manufactured or constantly drive at a high speed or in overly damp or dusty conditions, you will have to service the scooter more often. Always read the instructions before starting and make sure you have all the materials you need and a clear idea of what you are going to do.
- If your S01 is involved in an accident, request an inspection of the main components by a SILENCE Official Service Centre.
- Failure to properly maintain the scooter, correctly follow instructions or resolve a problem before driving could cause an accident in which there is a **SERIOUS RISK OF INJURY OR DEATH**. Always follow this schedule and any advice from your SILENCE dealer.
- There are some basic operations you may be able to do on your own (those that are the same for a combustion engine motorcycle, such as, for example, changing the brake pads). Only you can decide if you are capable and, therefore, whether or not you should personally carry out said task.
- Use the centre stand for any operations, always on a flat, hard horizontal surface.
- Always carry out any operations on the scooter when it is turned off and with the keys removed (unless indicated otherwise in the instructions), to avoid starting it accidentally and having an accident with the engine running.
- Take care with hot parts, particularly the disc brakes just after driving your S01. Let them cool down first.

3) Operations and frequency

ZONE	WHAT TO DO	FREQUENCY
Painted parts	Clean with shine restorer.	Every month
Rubber parts	Clean with special products to protect the rubber.	Every month
Aluminium parts	Clean with protective spray to prevent rust. Remove any rust on the aluminium carefully with steel wool and soap.	Every week
Metal parts	Use oil to clean and lubricate metal parts (in particular, the battery undercarriage, to ensure that it correctly unfolds).	Every month
Seat	Clean with a soft sponge to remove any insects or dirt.	Every day of use
Dashboard	Clean any hardened dirt with a soft sponge.	As needed
Tyres	Make sure that the pressure is as indicated in the “Scooter specifications (structure + motor)” section.	Every week
Lights	Clean any hardened dirt with a soft sponge.	As needed
Windshield	Clean with a soft sponge to remove any insects or dirt.	Every day of use
Suspensions	Check for leaks in both the fork and rear shock absorber.	Every month

4) Cleaning

Clean the scooter as indicated in the previous section. As with any vehicle, it is important to clean it regularly to keep it in good condition. It is the user’s responsibility to properly protect the scooter from aggressive contaminants in the air and the effects of salt on the roads.

WARNING: Do not clean the battery with a lot of water or a high-pressure washer. Never use harsh detergents on the scooter. Try to find gentle cleaning products for the vehicle that are environmentally friendly.

When you dry your scooter, always use a clean and smooth cloth. Dirty or rough cloths can scratch the flat, shiny surfaces, while clean and smooth ones will reduce scratching. Never use hard cloths or sponges.

5) Storage

If you are not going to be using your scooter for a long period of time, read and follow these instructions:

- Clean the scooter and let it dry **completely** before storing it. Any traces of water could cause contact problems on the electronic components.
- Make sure the scooter is supported by its **centre** stand.
- Check the scooter to make sure there have not been any problems in the past.
- A **cover** protects your scooter from the elements and is a good investment. Put some kind of **protection** on the floor to protect it from any leaks.
- **Charge the battery completely** at least once a month.

6) Checks before driving

Charge level

Check the charge level on the LCD screen. If it is too low, recharge the battery before using your scooter:

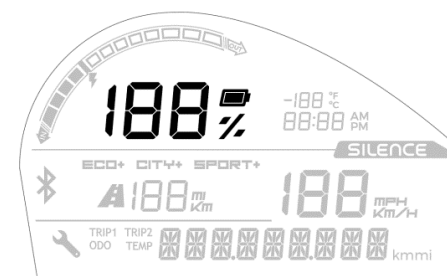

Lamps and indicator lights

Replace any parts that don't work properly or have been damaged before driving. When the speedometer lights do not work properly, they start flashing more quickly to indicate that there is some sort of problem.

Stands

Make sure both the side stand and centre stand are folded away. The side stand has a sensor that prevents the scooter from being driven when it is out, but the centre stand does not.

Tyres

Always make sure there are no punctures, cracks or tears in the tyres, and that the treads are not worn down. Never drive with worn or defective tyres. Refer to the “**Scooter specifications (structure + motor)**” section for more information about the correct inflation pressures of your scooter’s tyres. Driving with the incorrect tyre pressure can damage the tyre and cause an accident, as well as reduce its lifespan.

Rear tyre

It is very important to ensure the correct pressure levels on the rear tyre, since the motor is housed inside this wheel. It is important to remember that this vehicle has more weight on the rear wheel than conventional vehicles (those without an in-wheel motor), so the rim or motor can be affected when going over kerbs, potholes or road humps if travelling at the same speed as a conventional vehicle.

WARNING: If you go over kerbs, potholes or road humps at a high speed, you could damage the vehicle’s rim and/or motor.

Brakes

Brake fluid

The brake fluid tanks are located on the top of the handlebar, one on each side. Check the levels with the scooter resting on both wheels, not on either of the stands.

The brake fluid should never fall below the **MIN** line on the tank. Air can get into the tank if it is empty, which can cause problems in the scooter’s brake system and compromise safety when driving.

Levels should always be checked and the fluid must be changed every 2 years. If there is not enough, add more DOT4 brake fluid.

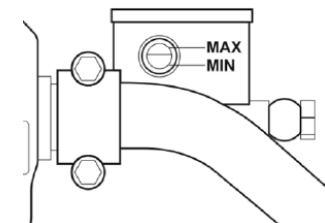

WARNING: Brake fluid can damage the scooter's paint and plastic parts if spilled accidentally.

Brake fluid can cause damage and injuries if not handled properly and safely.

If you get brake fluid on your skin, wash it off immediately with water. If you get brake fluid in your eyes, rinse them with water and seek urgent medical attention.

Brake pads

When the brake pads are less than 1 mm thick, they are less effective. Consult your point of sale for replacements.

Brake levers

If there is too much play on the brake levers, but the brake pads are still in good condition, take the scooter to the official point of sale as soon as possible to have it checked:

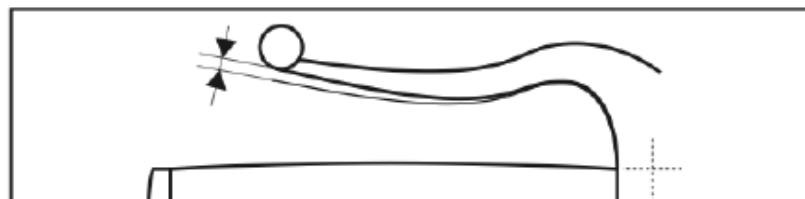

Before the “D” icon lights up (scooter ready to drive), make sure that the braking system is working properly: squeeze the left and right brake levers at the same time to make sure there is resistance to the pressure on both.

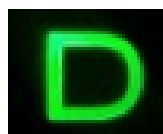

Adjusting the brake lever

The position of the left and right brake levers can be adjusted for greater driving comfort. The adjustment device is mounted on the brake levers themselves.

Rotate the adjustment device forwards or backwards to adjust the position of the brake levers.

WARNING

The brake lever adjustments only affect the lever position and have no effect on the braking power or range.



Battery anchoring

Check the correct fastening of the battery, verifying that when pulling it firmly it does not come out of the scooter.

TROUBLESHOOTING

For the faults described here, it is assumed that only the final components are the cause of the problem. If the problem persists after replacing the final component, take the scooter to the official point of sale.

All of our scooters are examined carefully before they are sent to our dealer. Incidents may appear even after the scooter is inspected. The following table offers guidelines for identifying the problem and, if possible, repairing it yourself. If you cannot solve the problem, take the scooter to the SILENCE Official Service Centre, so it can be inspected and repaired if needed.

INCIDENT	PROBABLE CAUSE	SOLUTION
A light/lamp is not working (headlight, tail light, indicator lights)	Damaged fuses. The component is defective or the connectors are damaged.	Check the fuses and connectors, and if the problem persists, take the scooter to the nearest official dealer.
The scooter does not accelerate	Throttle not adjusted properly	Check the connection between the throttle and the electrical installation. Take the scooter to the nearest official dealer.
The scooter will not start	Key not in the ignition The scooter is charging The battery is dead Damaged fuses	Check that the key is in the ignition Wait for the battery to charge and disconnect the charger Charge the battery fully Replace damaged fuses If the problem persists, take the scooter to the nearest official dealer
The battery will not charge. Battery percentage does not increase	Problem with the battery, problem with the charger Power is not getting to the charger	Check the scooter-battery and scooter-mains connection (charging the battery in the scooter) Check the battery-mains connection (charging the battery outside the scooter)
The brakes do not work properly (with the pads being ok)	Incorrect tyre air pressure The tyres are worn Excessive or incorrectly distributed load Air in the brake circuit	The air pressure must be checked and adjusted accordingly (as indicated in the "TECHNICAL SPECIFICATIONS" section) Replace the tyres Check to see whether the load is excessive. Reduce or redistribute the load Take the scooter to the nearest official dealer
Error in the state of charge (SoC)	The charge gauge is not synchronised with the actual state of charge	Charge the battery fully If the problem persists, take the scooter to your nearest official dealer
Message on screen: "0x..."	Depends on the problem	Contact your nearest official distributor

VEHICLE AND BATTERY WARRANTY

1) Delivery to buyer

This document is the basis for processing any warranty claims (warranty claims cannot be processed if the documents are not filled in properly or are incomplete):

VIN (Vehicle Identification Number)
<p>Full name.....</p> <p>Address.....</p> <p>City/Town.....</p> <p>Postcode.....</p> <p>Country.....</p> <p>Telephone / Mobile phone.....</p> <p>e-mail.....</p>

<p>.....</p> <p>Date of Delivery</p>
<p>Dealer Number</p>

2) Warranty terms and conditions (grounds for voiding the warranty)

As a general rule, this vehicle and its battery are warranted in accordance with the limits established as such in the current legislation of the country in which it is purchased, counted from the date of delivery and receipt, covering any design and manufacturing defects. Any agreements that differ from the warranty terms and conditions above must be confirmed in writing by the manufacturer.

Parts subject to normal wear and tear, such as tyres, disc brakes, brake pads, etc., are not covered by this warranty. The manufacturer and the chosen garage will decide which defective parts will be replaced or repaired.

The warranty will be VOID if:

- a) The end user has not followed the regulations when handling the vehicle.
- b) The end user has not carried out any or has only carried out some of the inspections required in the service booklet or has taken the scooter to be repaired at a garage that is not authorised by the manufacturer (see the “**Inspection: Scooter and**” section).
- c) The vehicle has been modified or changed in any way or fitted with parts that are not among the original features certified expressly by the manufacturer (provided that the problem is associated with the modification).
- d) The vehicle has been used in sporting competition.
- e) The operations, maintenance and service instructions set out in this manual have not been followed.

WARNING: Regular use, definition: At least once a week, for a minimum of 10 hours.

Occasional use -> When not being used regularly, the scooter should be fully charged before it is left parked for more than one week.

The battery must be charged fully once every 30 days to ensure the validity of the warranty.

TECHNICAL NOTICE: Silence vehicles feature an internal communication bus (CAN bus), which is used by all electronic devices to communicate and ensure proper functioning of the vehicle: Electronic Control Unit (ECU), Battery Management System (BMS), Motor Control Unit (MCU), Telematics Control Unit (TCU), among others.

It is expressly prohibited to connect to and communicate via any device through the CAN bus, since this might alter the operation of the vehicle, affect the product quality, pose a risk to the vehicle's safety and void the warranty.

3) Inspection: Scooter and Battery

Each S01 must pass a series of regular inspections, based on the kilometres travelled or at least once a year (if the scooter has not travelled the kilometres necessary to require an inspection within a year). The same is true for the battery packs (“be”), which have their own inspection intervals. For batteries purchased with the scooter, the inspections will be the same as for the scooter and must be done at the same time.

The number of kilometres between inspections **of the scooter and battery** is shown automatically on the scooter’s display (the screen will show a **spanner** icon to indicate that it is time for an inspection based on the kilometres travelled) and is as follows: first inspection at **1,500 km**, second at **5,000 km**, third at **10,000 km** and subsequent inspections every **5,000 km**.

The **scooter’s** inspections must be carried out within one year of the previous inspection (**at least one per year, the first one 3 months after purchase**).

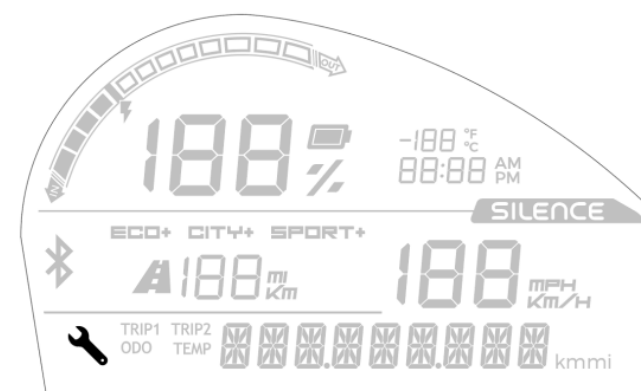

Information on what to inspect is provided in the corresponding manuals/maintenance schedules for the scooter and the battery, which are available to SILENCE Official Service Centres.

S01 inspection log (both scooter and battery):

INSPECTION No.	DATE	ODOMETER READING	OFFICIAL SERVICE SIGNATURE
DATE OF VEHICLE REGISTRATION/...../.....			
1st INSPECTION BEFORE:	+3 months ↓/...../.....	or 1,500 km
	must be greater than ↓		
1st	INSPECTION INFO:/...../.....km
	NEXT INSPECTION BEFORE: +1 year ↓/...../.....	+5,000 km ↓km	
	must be greater than ↓	must be greater than ↓	
2nd	INSPECTION INFO:/...../.....km
	NEXT INSPECTION BEFORE: +1 year ↓/...../.....	+5,000 km ↓km	
	must be greater than ↓	must be greater than ↓	
3rd	INSPECTION INFO:/...../.....km
	NEXT INSPECTION BEFORE: +1 year ↓/...../.....	+5,000 km ↓km	
	must be greater than ↓	must be greater than ↓	
4th	INSPECTION INFO:/...../.....km
	NEXT INSPECTION BEFORE: +1 year ↓/...../.....	+5,000 km ↓km	
	must be greater than ↓	must be greater than ↓	
5th	INSPECTION INFO:/...../.....km
	NEXT INSPECTION BEFORE: +1 year ↓/...../.....	+5,000 km ↓km	
	must be greater than ↓	must be greater than ↓	
6th	INSPECTION INFO:/...../.....km
	NEXT INSPECTION BEFORE: +1 year ↓/...../.....	+5,000 km ↓km	
	must be greater than ↓	must be greater than ↓	

INSPECTION No.	DATE	ODOMETER READING	OFFICIAL SERVICE SIGNATURE
7th	INSPECTION INFO:/...../.....km
	NEXT INSPECTION BEFORE: +1 year ↓/...../.....	+5,000 km ↓km	
	must be greater than ↓	must be greater than ↓	
8th	INSPECTION INFO:/...../.....km
	NEXT INSPECTION BEFORE: +1 year ↓/...../.....	+5,000 km ↓km	
	must be greater than ↓	must be greater than ↓	
9th	INSPECTION INFO:/...../.....km
	NEXT INSPECTION BEFORE: +1 year ↓/...../.....	+5,000 km ↓km	
	must be greater than ↓	must be greater than ↓	
10th	INSPECTION INFO:/...../.....km
	NEXT INSPECTION BEFORE: +1 year ↓/...../.....	+5,000 km ↓km	
	must be greater than ↓	must be greater than ↓	
11th	INSPECTION INFO:/...../.....km
	NEXT INSPECTION BEFORE: +1 year ↓/...../.....	+5,000 km ↓km	
	must be greater than ↓	must be greater than ↓	
12th	INSPECTION INFO:/...../.....km

